

# Acer

## Aspire 9410 / 7110 TravelMate 5610 / 5110 Service Guide

Service guide files and updates are available on the ACER/CSD web. For more information, please refer to <http://csd.acer.com.tw>

---

PRINTED IN TAIWAN

---

## Revision History

Please refer to the table below for the updates of Aspire 9410 / 7110 and TravelMate 5610 / 5110 service guide.

Date	Chapter	Updates

---

## **Copyright**

Copyright© 2006 by Acer Incorporated. All rights reserved. No part of this publication may be reproduced, transmitted, transcribed, stored in a retrieval system, or translated into any language or computer language, in any form or by any means, electronic, mechanical, magnetic, optical, chemical, manual or otherwise, without the prior written permission of Acer Incorporated.

---

## Disclaimer

The information in this guide is subject to change without notice.

Acer Incorporated makes no representations or warranties, either expressed or implied, with respect to the contents hereof and specifically disclaims any warranties of merchantability or fitness for any particular purpose. Any Acer Incorporated software described in this manual is sold or licensed "as is". Should the programs prove defective following their purchase, the buyer (and not Acer Incorporated, its distributor, or its dealer) assumes the entire cost of all necessary servicing, repair, and any incidental or consequential damages resulting from any defect in the software.

Acer is a registered trademark of Acer Incorporated.

Intel is a registered trademark of Intel Corporation.

Pentium and Pentium D are trademarks of Intel Corporation.

Other brand and product names are trademarks and/or registered trademarks of their respective holders.

---

## Conventions

The following conventions are used in this manual:

SCREEN MESSAGES	Denotes actual messages that appear on screen.
NOTE	Gives bits and pieces of additional information related to the current topic.
WARNING	Alerts you to any damage that might result from doing or not doing specific actions.
CAUTION	Gives precautionary measures to avoid possible hardware or software problems.
IMPORTANT	Reminds you to do specific actions relevant to the accomplishment of procedures.

---

## Preface

Before using this information and the product it supports, please read the following general information.

1. This Service Guide provides you with all technical information relating to the BASIC CONFIGURATION decided for Acer's "global" product offering. To better fit local market requirements and enhance product competitiveness, your regional office MAY have decided to extend the functionality of a machine (e.g. add-on card, modem, or extra memory capability). These LOCALIZED FEATURES will NOT be covered in this generic service guide. In such cases, please contact your regional offices or the responsible personnel/channel to provide you with further technical details.
2. Please note WHEN ORDERING FRU PARTS, you should check the most up-to-date information available on your regional web or channel. For whatever reason, if a part number change is made, it will not be noted in the printed Service Guide. For ACER-AUTHORIZED SERVICE PROVIDERS, your Acer office may have a DIFFERENT part number code to those given in the FRU list of this printed Service Guide. You MUST use the list provided by your regional Acer office to order FRU parts for repair and service of customer machines.

---

# Table of Contents

## Chapter 1 System Specification 1

Features .....	1
Platform .....	1
System Memory .....	1
Display and Graphics .....	1
Storage Subsystem .....	2
Communication .....	2
I/O Interface .....	2
Power Subsystem .....	3
Dimensions and Weight .....	3
Environment .....	3
Block Diagram .....	4
Outlook Tour .....	5
Front View .....	5
Closed Front View .....	6
Left View .....	7
Right View .....	7
Rear View .....	8
Base View .....	9
Using the Keyboard .....	10
Lock keys and Embedded Numeric Keypad .....	10
Windows keys .....	11
Hotkeys .....	11
Special keys .....	12
Indicators .....	14
Easy-launch Buttons .....	15
Touch pad .....	16
Touch pad Basics .....	16
Acer Empowering Technology .....	18
Acer eDataSecurity Management .....	19
Acer eLock Management .....	21
Acer ePerformance Management .....	22
Acer eRecovery Management .....	23
Acer eSettings Management .....	24
Acer eNet Management .....	25
Acer ePower Management .....	27
Acer ePresentation Management .....	29
Acer OrbiCam .....	30
Using the System Utilities .....	36
Acer GridVista (dual-display compatible) .....	36
Launch Manager .....	37
Norton AntiVirus .....	38
How do I check for viruses? .....	38
Hardware Specification and Configuration .....	39
BIOS Setup Utility .....	48
Invoking BIOS Setup .....	48



---

## Chapter 2 System Utilities 48

Information .....	49
Main .....	50
Security .....	52
Boot .....	54
Exit .....	55

## Chapter 3 Machine Disassembly and Replacement 56

General Information .....	57
Before You Begin .....	57
Disassembly Procedure Flowchart .....	58
Disassembly Procedure .....	60
Removing the Battery Pack .....	60
Removing the HDD Module .....	60
Removing the MiniPCI Card and the Memory .....	61
Removing the Keyboard .....	62
Separating the LCD Module and Main Unit .....	63
Disassembling the Main Unit .....	64
LCD Disassembly .....	71

## Chapter 4 Troubleshooting 75

System Check Procedures .....	76
External Diskette Drive Check .....	76
External CD-ROM Drive Check .....	76
Keyboard or Auxiliary Input Device Check .....	76
Memory Check .....	77
Power System Check .....	77
Check the Power Adaptor .....	77
Check the Battery Pack .....	78
Touch pad Check .....	78
Power-On Self-Test (POST) Error Message .....	80
Index of Error Messages .....	81
Error Message List .....	81
Phoenix BIOS Beep Codes .....	82
Index of Symptom-to-FRU Error Message .....	87
Intermittent Problems .....	91
Undetermined Problems .....	92
Top View .....	93

## Chapter 5 Jumper and Connector Location 93

Top View .....	93
Bottom View .....	95

## Chapter 6 FRU (Field Replaceable Unit) List 96

Exploded Diagram .....	97
Parts .....	98

# System Specification

---

## Features

### Platform

#### Aspire 9410 / TravelMate 5610 Series

- ❑ Intel® Core™ Duo processor T2300/T2400/T2500/T2600 (2MB L2 cache, 1.66/1.83/2/2.16GHz, 667MHz FSB)
- ❑ Mobile Intel® 945GM/PM Express chipset DDR2 533/667 memory
- ❑ Intel® PRO/Wireless 3945ABG network connection (dual-band tri-mode 802.11a/b/g) Wi-Fi CERTIFIED™ solution, supporting Acer SignalUp™ wireless technology

#### Aspire 7110 / TravelMate 5110 Series

- ❑ Intel® Celeron® M processor 410/420/430 (1MB L2 cache, 1.46/1.60/1.73GHz, 533MHz FSB)
- ❑ Mobile Intel® 940GML Express chipset
- ❑ Acer InViLink™ 802.11b/g Wi-Fi CERTIFIED™ solution, supporting Acer SignalUp™ wireless technology

### System Memory

#### Aspire 9410 / TravelMate 5610 Series

- ❑ Up to 2GB of DDR2 533/667MHz memory, upgradeable to 4GB using two soDIMM modules (dual-channel support)

#### Aspire 7110 / TravelMate 5110 Series

- ❑ Up to 1GB of DDR2 533MHz memory, upgradeable to 2GB using two soDIMM modules (dual-channel support)

### Display and Graphics

- ❑ 17.1" WXGA + 200-nit Acer CrystalBrite™ colour TFT LCD (Aspire 9410 / 7110 series) or high brightness TFT LCD (TravelMate 5610 / 5110 series), 1440 x 900 pixel resolution, supporting simultaneous multi-window viewing via Acer GridVista™
- ❑ NVIDIA® GeForce® Go 7300 up to 512MB TurboCache™ (256MB of dedicated GDDR2 VRAM, 256MB of shared system memory), supporting Microsoft DirectX 9.0, Shader Model 3.0, OpenEXR High Dynamic Range (HDR) technology, NVIDIA PowerMizer
- ❑ Mobile Intel® 945GM/940GML Express chipset (Aspire 9410 / 7110 series) or 945GM Express chipset (TravelMate 5610 / 5110 series) with integrated 3D graphics, featuring Intel® Graphics Media Accelerator (GMA) 950, up to 224MB of shared system memory, supporting Microsoft® DirectX® 9.0 and PCI Express® and dual independent displays
- ❑ 16.7 million colours

- 
- ❑ MPEG-2/DVD hardware-assisted capability
  - ❑ Acer CinemaVision™ technology (Aspire 9410 / 7110 series)
  - ❑ Acer ClearVision™ technology (Aspire 9410 / 7110 series)

**NOTE:** TurboCache™ memory allocation varies depending on configuration.

## Storage Subsystem

- ❑ 60/80/100/120GB or higher hard disk drive (Aspire 9410 / 7110 series)
- ❑ 80/100/120GB or higher hard disk drive with Acer Disk Anti-Shock Protection, DASP (TravelMate 5610 / 5110 series)
- ❑ Optical drive options:
  - ❑ DVD-Super Multi double-layer
  - ❑ DVD-Dual double-layer
  - ❑ DVD/CD-RW combo drive
- ❑ 5-in-1 card reader, supporting Secure Digital (SD), MultiMediaCard (MMC), Memory Stick® (MS), Memory Stick PRO™ (MS PRO), xD-Picture Card™ (xD)

## Communication

- ❑ Acer Video Conference featuring Voice and Video over internet Protocol (VVoIP) support via Acer OrbiCam™ and optional Acer Bluetooth® VoIP phone
- ❑ Acer OrbiCam™ integrated 1.3 megapixel or 310,000 pixel CMOS camera (for selected models), featuring:
  - ❑ 225 degree ergonomic rotation
  - ❑ Acer VisageON™ technology (for 1.3 megapixel camera models only)
  - ❑ Acer PrimaLite™ technology
- ❑ Modem: 56K ITU V.92 with PTT approval; Wake-on-Ring ready
- ❑ LAN: gigabit Ethernet; Wake-on-LAN ready
- ❑ WPAN: Bluetooth® 2.0 + EDR (Enhanced Data Rate)
- ❑ WLAN: Intel® PRO/Wireless 3945ABG network connection (dual-band tri-mode 802.11a/b/g) Wi-Fi CERTIFIED™ solution, supporting Acer SignalUp™ wireless technology (Aspire 9410 / TravelMate 5610 series); Integrated Acer InviLink™ 802.11b/g Wi-Fi CERTIFIED™ solution, supporting Acer SignalUp™ wireless technology (Aspire 7110 / TravelMate 5110 series)

## I/O Interface

- ❑ PC Card slot (one Type II)
- ❑ Four USB 2.0 ports
- ❑ External display (VGA) port
- ❑ Headphones/speaker/line-out jack with S/PDIF support
- ❑ Microphone-in jack
- ❑ Line-in jack

- 
- Ethernet (RJ-45) port
  - Modem (RJ-11) port
  - DC-in jack for AC adapter

## **Power Subsystem**

- ACPI 2.0 CPU power management standards: Stand-by and Hibernation power-saving modes support
- 71W 4800mAh (8-cell) or 44W 4000mAh (6-cell) Li-Ion battery pack
- Acer QuicCharge™ technology: 80% charge in 1 hour; 2-hour rapid charge system-off; 2.5-hour charge-in-use
- 3-pin 90W AC adapter

## **Dimensions and Weight**

- With Acer OrbiCam™
  - 400 (W) x 295 (D) x 31.4/39.9 (H) mm (15.75 x 11.61 x 1.24/1.57 inches)
  - 3.81 kg (8.39 lbs.) with 8-cell battery pack
  - 3.68 kg (8.10 lbs.) with 6-cell battery pack
- Without Acer OrbiCam™
  - 400 (W) x 295 (D) x 31.4/39.9 (H) mm (15.75 x 11.61 x 1.24/1.57 inches)
  - 3.79 kg (8.35 lbs.) with 8-cell battery pack
  - 3.66 kg (8.06 lbs.) with 6-cell battery pack

## **Environment**

- Temperature
  - Operating: 5 °C to 35 °C
  - Non-operating: -20 °C to 65 °C
- Humidity (non-condensing)
  - Operating: 20% to 80%
  - Non-operating: 20% to 80%

# Block Diagram

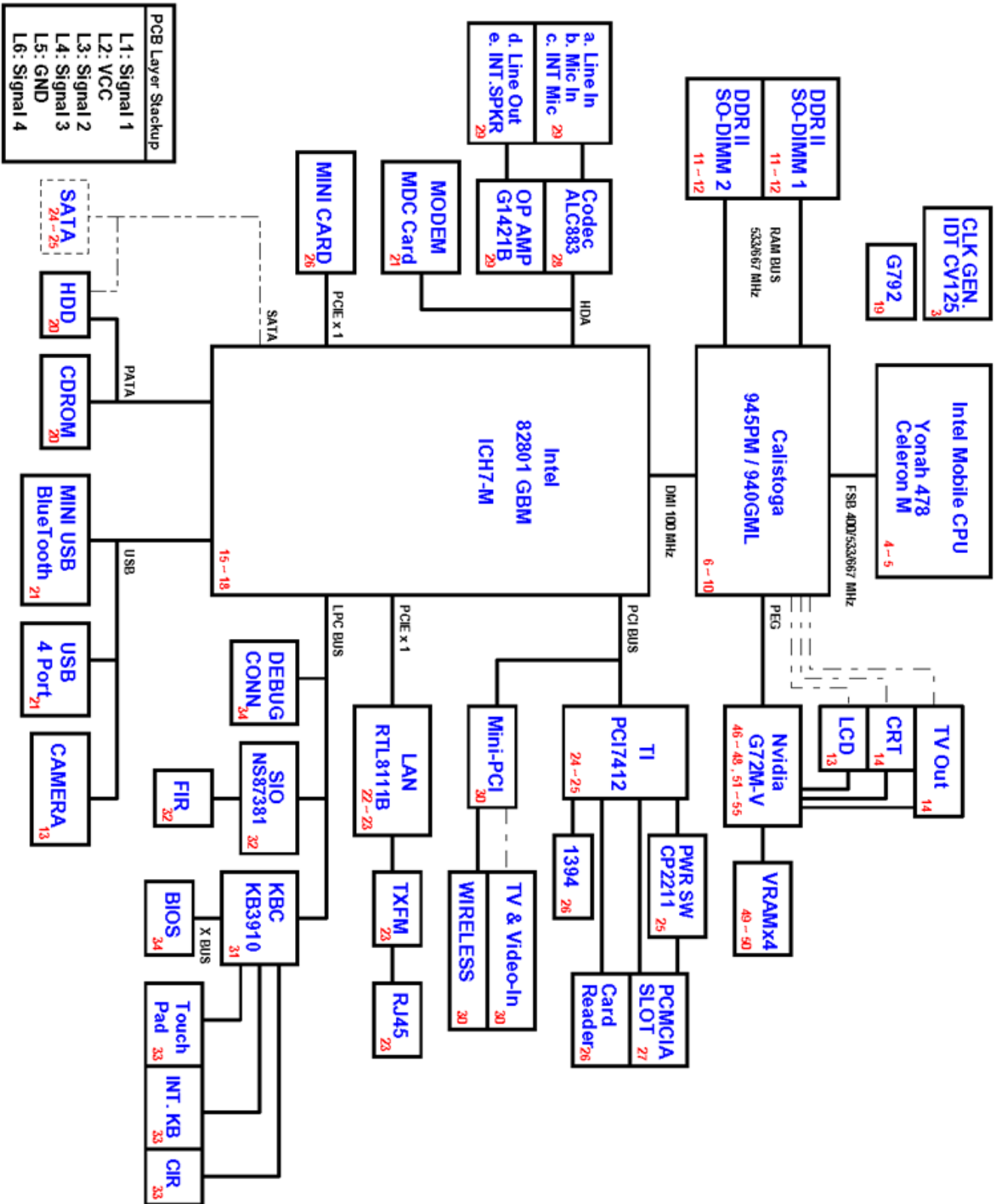



# Outlook Tour

## Front View

Left: Aspire 9410 / 7110 Series

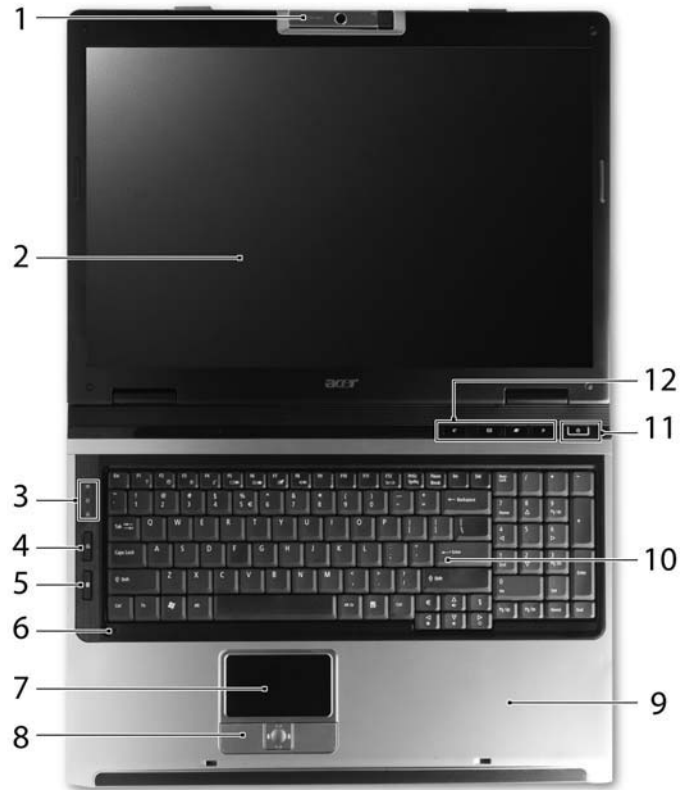
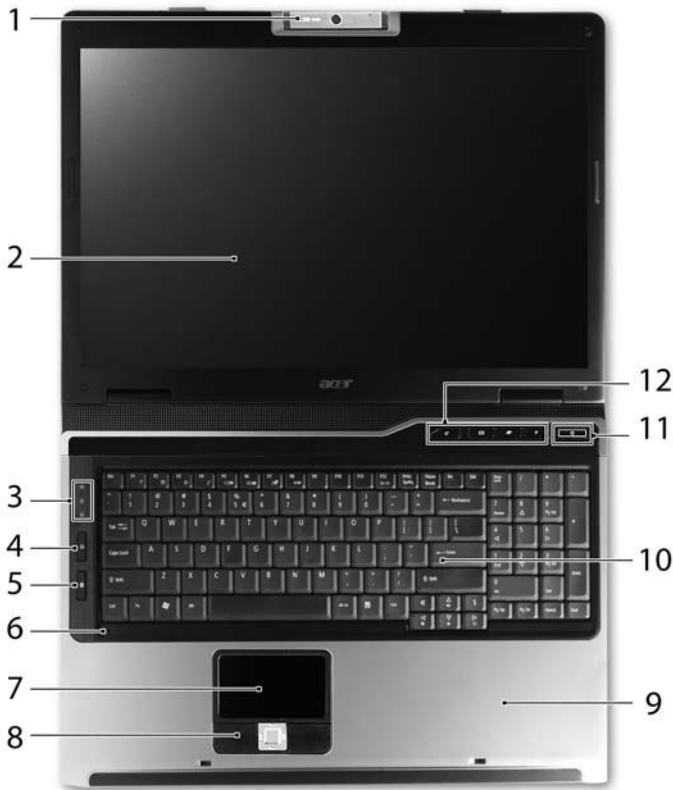
Right: TravelMate 5610 / 5110 Series



#	Icon	Item	Description
1	N/A	Built-in camera	1.3 megapixel or 310,000 pixel web camera for video communication (for selected models)
2	N/A	Display screen	Also called Liquid-Crystal Display (LCD), displays computer output.
3	N/A	Status indicators	Light-Emitting Diodes (LEDs) that light up to show the status of the computer's functions and components.
4		Wireless communication button	Enable/disables Wireless function. Indicates the status of wireless LAN communications.
5		Bluetooth communication button	Enable/disables Bluetooth function. Indicates the status of Bluetooth communications.
6	N/A	Microphone	Internal microphone for sound recording
7	N/A	Touchpad	Touch-sensitive pointing device which functions like a computer mouse
8	N/A	Click buttons (left, center and right)	The left and right buttons function like the left and right mouse buttons; the center button serves as a four-way scroll button.





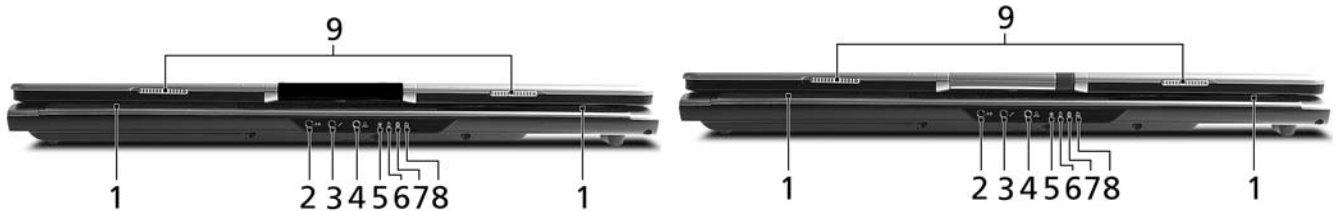

9	N/A	Palmrest	Comfortable support area for your hands when you use the computer.
10	N/A	Keyboard	Serves for entering data into your computer.
11	N/A	Power button	Turns the computer on and off.
12	N/A	Easy-launch buttons	Buttons for launching frequently used programs.

## Closed Front View

Left: Aspire 9410 / 7110 Series

Right: TravelMate 5610 / 5110 Series



#	Icon	Item	Description
1	N/A	Speakers	Left and right speakers deliver stereo audio output.
2		Line-in jack	Accepts audio line-in devices (e.g., audio CD player, stereo walkman).
3		Microphone-in jack	Accepts input from external microphones.
4		Headphones/speaker/ line-out jack with S/PDIF support	Connects to audio line-out devices (e.g., speakers, headphones).
5		Power indicator	Indicates the computer's power status.
6		Battery indicator	Indicates the computer's battery status.
7		Bluetooth communication indicator	Indicates the status of Bluetooth communication.
8		Wireless communication indicator	Indicates the status of wireless LAN communication.
9	N/A	Latch	Locks and releases the lid.

## Left View

Left: Aspire 9410 / 7110 Series

Right: TravelMate 5610 / 5110 Series





#	Icon	Item	Description
1		Kensington lock slot	Connects to a Kensington-compatible computers security lock.
2	N/A	Optical disk drive	Internal optical drive; accepts CDs or DVDs (slot-load or tray-load depending on model).
3	N/A	Optical disk access indicator	Lights up when the optical disk drive is active.
4	N/A	Optical disk drive eject button	Ejects the drive tray from the drive (location depends on model).
5	N/A	Emergency eject hole	Ejects the drive tray when the computer is turned off.

## Right View

Left: Aspire 9410 / 7110 Series

Right: TravelMate 5610 / 5110 Series



#	Icon	Item	Description
1	N/A	PC Card slot eject button	Ejects the PC Card from the slot.
2		PC Card slot	Accepts one Type II PC Card.
3		5-in-1 card reader	Accepts Memory Stick (MS), Memory Stick Pro (MS PRO), MultiMediaCard (MMC), Secure Digital (SD) and xD-Picture Card (xD).
4		Three USB 2.0 ports	Connect to USB 2.0 devices (e.g., USB mouse, USB camera).
5	N/A	Ventilation slots	Enable the computer to stay cool, even after prolonged use.







6		DC-in jack	Connects to an AC adapter.
---	---	------------	----------------------------

## Rear View

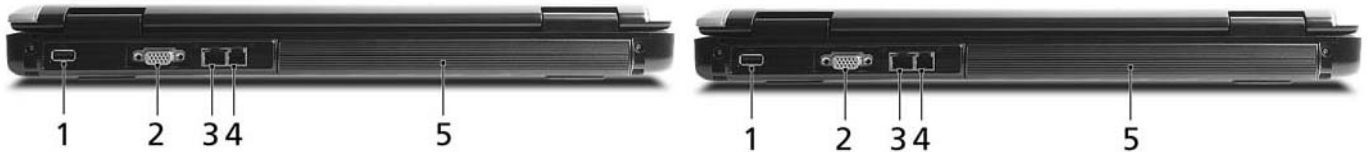
Left: Aspire 9410 / 7110 Series

Right: TravelMate 5610 / 5110 Series



#	Icon	Item	Description
1		USB 2.0 ports	Connect to USB 2.0 devices (e.g., USB mouse, USB camera).
2		External display (VGA) port	Connects to an external display device (e.g., external monitor, LCD projector).
3		Modem (RJ-11) port	Connects to a phone line.
4		Ethernet (RJ-45) port	Connects to an Ethernet 10/100/1000-based networks.
5	N/A	Battery	Powers the computer.

## Base View

Upper: Aspire 9410 / 7110 Series

Lower: TravelMate 5610 / 5110 Series

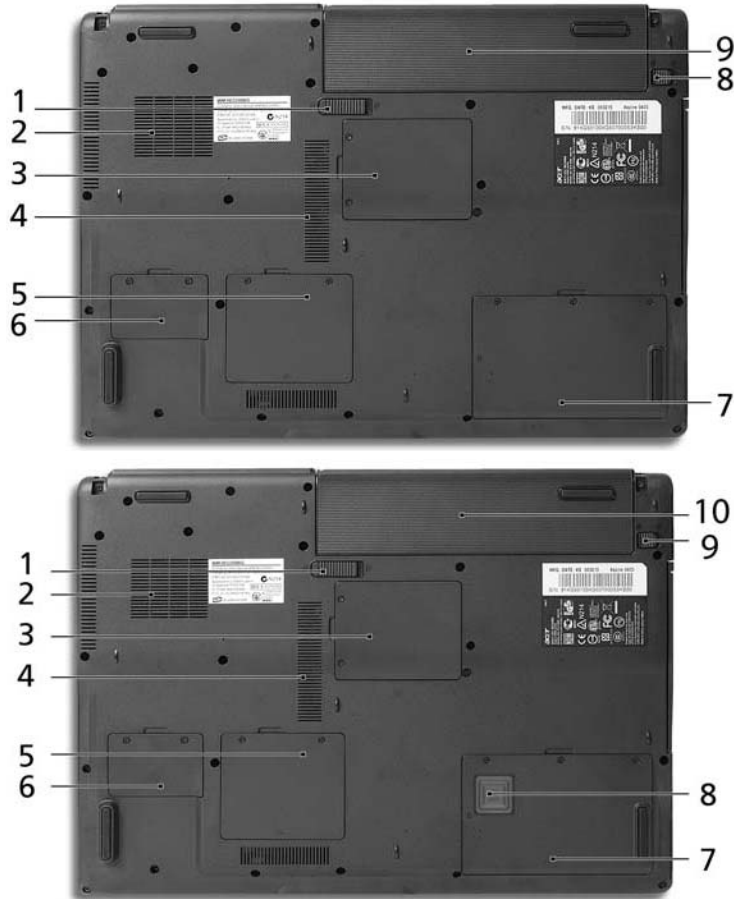

#	Icon	Item	Description
1	N/A	Battery release latch	Releases the battery for removal.
2	N/A	Cooling fan	Helps keep the computer cool. <b>NOTE:</b> Do not cover or obstruct the opening of the fan.
3	N/A	Mini PCI card bay	Houses the computer's Mini PCI card.
4	N/A	Ventilation slots	Enable the computer to stay cool, even after prolonged use.
5	N/A	Memory compartment	Houses the computer's main memory.
6	N/A	PCI Express Mini Card bay	Houses the computer's PCI Express Mini card.
7	N/A	Hard disk bay	Houses the computer's hard disk (secured with screws).
8	N/A	Battery lock	Locks the battery in position.
9	N/A	Battery bay	Houses the computer's battery pack.
8	N/A	Acer DASP (Disk Anti-Shock Protection)	Protects the hard disk drive from shocks and bumps. (TravelMate 5610 / 5110 Series)
9	N/A	Battery lock	Locks the battery in position.
10	N/A	Battery bay	Houses the computer's battery pack.

# Using the Keyboard

The full-sized keyboard includes an embedded numeric keypad, separate cursor, lock, Windows, function and special keys.

## Lock keys and Embedded Numeric Keypad

The keyboard has three lock keys which you can toggle on and off.

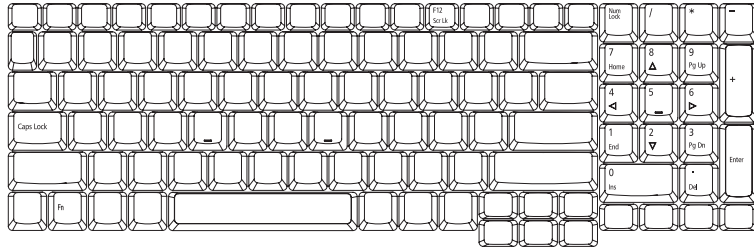









Lock	Description
Caps Lock	When Caps Lock is on, all alphabetic characters are typed in uppercase.
Num Lock <b>Fn + F11</b>	When Num Lock is on, the right hand side numeric keypad is in numeric mode. The keys function as a calculator (complete with the arithmetic operators +, -, *, and /). When Num Lock is off, the keys assume cursor and other shortcut functions.
Scroll Lock <b>Fn + F12</b>	When Scroll Lock is on, the screen moves one line up or down when you press the up or down arrow keys respectively. scroll Lock does not work with some applications.

The embedded numeric keypad functions like a desktop numeric keypad. It is indicated by small characters located on the upper right corner of the keycaps. To simplify the keyboard legend, cursor-control key symbols are not printed on the keys.

Desired access	Num Lock on	Num Lock off
Number keys on embedded keypad	Type numbers in a normal manner.	N/A
Cursor-control keys on embedded keypad	Hold <b>Shift</b> while using cursor-control keys.	Hold <b>Fn</b> while using cursor-control keys.
Main keyboard keys	Hold <b>Fn</b> while typing letters on embedded keypad.	Type the letters in a normal manner.

## Windows keys





The keyboard has two keys that perform Windows-specific functions.



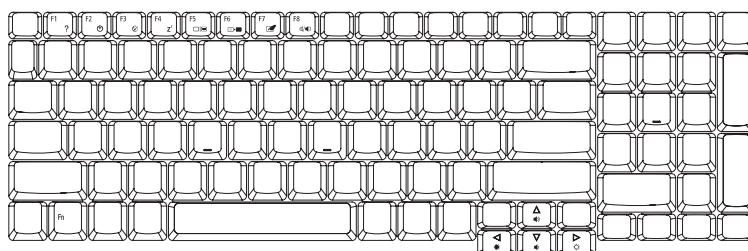





Key	Icon	Description
Windows key		<p>Press alone. This key has the same effect as clicking on the Windows Start button. It launches the Start menu. It can also be used with other keys to provide a variety of functions:</p> <ul style="list-style-type: none"> <li> + <b>Tab</b>: Activates the next Taskbar button.</li> <li> + <b>E</b>: Opens the My Computer window.</li> <li> + <b>F1</b>: Opens Help and Support.</li> <li> + <b>F</b>: Opens the Find (All Files dialog box).</li> <li> + <b>R</b>: Opens the Run dialog box.</li> <li> + <b>M</b>: Minimizes all windows.</li> </ul> <p><b>Shift</b> +  + <b>M</b>: Undoes the minimize all windows action.</p>
Application key		This key has the same effect as clicking the right mouse button. It opens the application's context menu.

## Hotkeys

The computer employs hotkeys or key combinations to access most of the computer's controls like screen brightness, volume output and the BIOS utility. To activate hotkeys, press and hold the <Fn> key before pressing the other key in the hotkey combination.



Hot Key	Icon	Function	Description
<b>Fn + F1</b>		Hot key help	Displays help on hot keys.
<b>Fn + F2</b>		Acer eSetting	Launches the Acer eSettings in Acer Empowering Technology.
<b>Fn + F3</b>		Acer ePower Management	Launches the Acer ePower Management in Acer Empowering Technology.
<b>Fn + F4</b>		Sleep	Leads the computer to Sleep mode.

Hot Key	Icon	Function	Description
Fn + F5		Display toggle	Switches the display output between the display screen, external monitor (if connected) and both.
Fn + F6		Screen blank	Turns off the display screen backlight to save power. Press any key to return.
Fn + F7		Touchpad toggle	Turns the internal touchpad on and off.
Fn + F8		Speaker toggle	Turns the speakers on and off.
Fn + ↑		Volume up	Increases the sound volume.
Fn + ↓		Volume down	Decreases the sound volume.
Fn + →		Brightness up	Increases the screen brightness.
Fn + ←		Brightness down	Decreases the screen brightness.

## Special keys

You can locate the Euro symbol and the US dollar sign on the upper-center and/or bottom-right side of the keyboard.

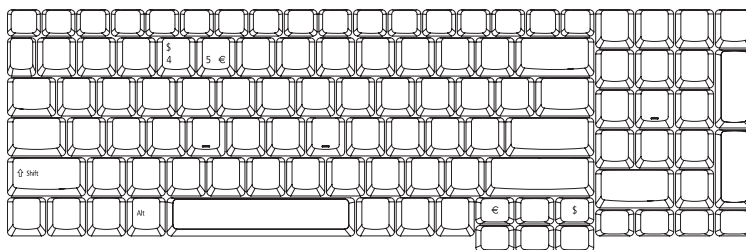

### The Euro Symbol

1. Open a text editor or word processor.
2. Either directly press the **Euro** key on the bottom-right side of the keyboard, or hold **Alt Gr** key then press the Euro symbol on the number **five** key.

**NOTE:** Some fonts and software do not support the Euro symbol. Please refer to [www.microsoft.com/typography/faq/faq12.htm](http://www.microsoft.com/typography/faq/faq12.htm) for more information.

### The US Dollar Sign

1. Open a text editor or word processor.

---

2. Either directly press the **\$** key on the bottom-right side of the keyboard, or hold **Shift** and then press the US dollar sign on the number **four** key.







**NOTE:** This function varies according to the language settings.

# Indicators

The computer provides an array of three indicators located above the keyboard, in addition to four indicators on the front cover. These indicators show the status of the computer and its components.



The front panel indicators are visible even when the computer cover is closed up.

Icon	Item	Description
	HDD	Indicates when the hard disk drive is active.
	Caps Lock	Lights up when Caps Lock is activated.
	Num Lock	Lights up when Num Lock is activated.
	Power	Lights when the computer is on.
	Battery	Lights when the battery is being charged.
	Bluetooth	Indicates the status of Bluetooth communication
	Wireless LAN	Indicates the status of wireless LAN communication

---

## Easy-launch Buttons

There are several conveniently located easy-launch buttons. They are one user-programmable button, web browser button, mail button, and Acer Empowering Key *e*. Press *e* to run the Acer Empowering Technology. Although the mail and web browser buttons are pre-set to E-mail and Internet programs, they can be redefined by users. To set the web browser, mail and programmable buttons, run the Acer Launch Manager.



Easy-launch button	Default application
<i>e</i>	Acer Empowering Technology (user-programmable)
Mail	E-mail application (user-programmable)
Web browser	Internet browser (user-programmable)
P	User-programmable



# Touchpad

The built-in touchpad is a pointing device that senses movement on its surface. This means the cursor responds as you move your finger across the surface of the touchpad. The central location on the palmrest provides optimum comfort and support.

## Touchpad Basics

Use the touchpad as follows:

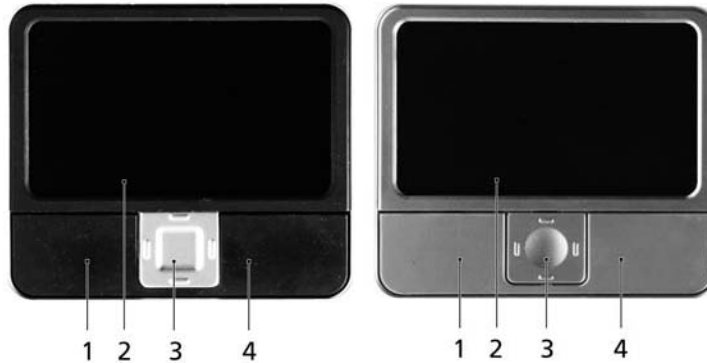

- ❑ Move your finger across the touchpad (2) to move the cursor.
- ❑ Press the left (1) and right (4) buttons located on the edge of the touchpad to perform selection and execution functions. These two buttons are similar to the left and right buttons on a mouse. Tapping on the touchpad (2) is the same as clicking the left button.
- ❑ Use the four-way scroll (3) button to scroll up or down and move left or right a page. This button mimics your cursor pressing on the right scroll bar of windows applications.

Function	Left button (1)	Right button (4)	Main touchpad (2)	Center button (3)
Execute	Quickly click twice.		Tap twice (at the same speed as double-clicking a mouse button).	
Select	Click once		Tap once	
Drag	Click and hold. Then slide your finger across the touchpad to drag the cursor over the selection.		Tap twice (at the same speed as double-clicking a mouse button); rest your finger on the touchpad on the second tap and drag the cursor.	
Access context menu		Click once		
Scroll				Click and hold to move up/down/left/right.

**NOTE:** Keep your fingers, as well as the surface of the touchpad dry and clean. The touchpad is sensitive to your finger movements: the lighter the touch, the better the response. Tapping hard will not increase

---

the touchpad's responsiveness.

**NOTE:** By default, vertical and horizontal scrolling is enabled on your touchpad. It can be disabled under Mouse settings in Windows Control Panel.

# Acer Empowering Technology

Acer's innovative Empowering Technology makes it easy to have access to the frequently used functions and manage the notebook. It features the following handy utilities:

- ❑ **Acer eDataSecurity Management** protects data with passwords and advanced encryption algorithms.
- ❑ **Acer eLock Management** limits access to external storage media.
- ❑ **Acer ePerformance Management** improves system performance by optimizing disk space, memory and registry setting.
- ❑ **Acer eRecovery Management** backs up and recovers data flexibly, reliably and completely.
- ❑ **Acer eSettings Management** accesses system information and adjusts settings easily.
- ❑ **Acer eNet Management** hooks up to location-based networks intelligently.
- ❑ **Acer ePower Management** extends battery power via versatile usage profiles.
- ❑ **Acer ePresentation Management** connects to a projector and adjusts display settings conveniently.



For more information, press the *e* key to launch the Empowering Technology menu, then click on the appropriate utility and select the Help function.

## Acer eDataSecurity Management

Acer eDataSecurity Management is a handy file encryption utility that protects the files from being accessed by unauthorized persons. It is conveniently integrated with Windows Explorer as a shell extension for quick and easy data encryption and decryption and also supports on-the-fly file encryption for MSN Messenger and Microsoft Outlook.

There are two passwords that can be used to encrypt and decrypt a file: the supervisor password and the file-specific password. The supervisor password is a “master” password that can decrypt any file on the system. The file-specific password is assigned when you encrypt each individual file.

Acer eDataSecurity Management setup wizard will prompt for a supervisor password and default file-specific password. This file-specific password will be used to encrypt files by default, or you can choose to enter your own file-specific password when encrypting a file.

**NOTE:** The password used to encrypt a file is the unique key that the system needs to decrypt it. If you lose the password, the supervisor password is the only other key capable of decrypting the file. **If you lose both passwords, there will be no way to decrypt the encrypted files! Be sure to safeguard all related password.**



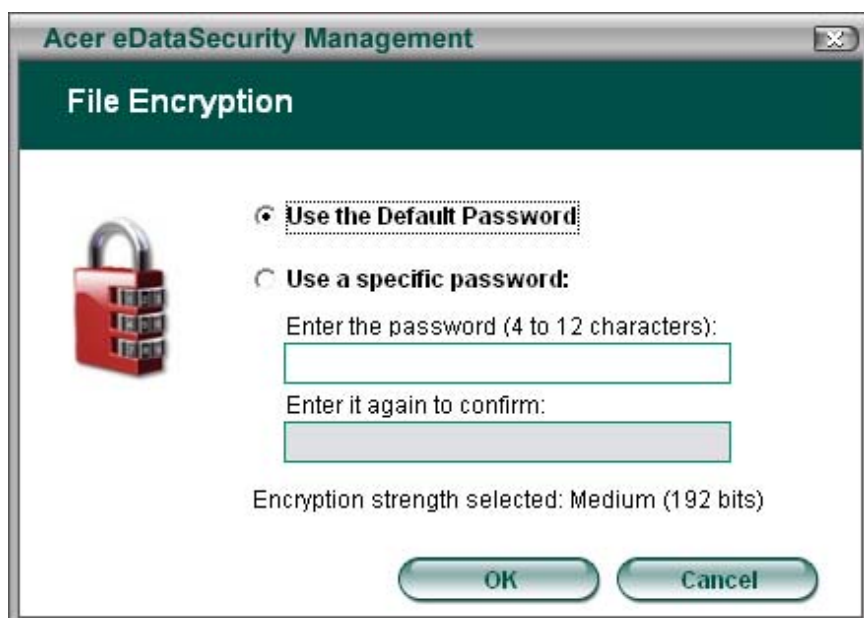

## Acer eLock Management

Acer eLock Management is a security utility that allow you to lock up your removable data, optical and floppy drives to ensure that data can not be stolen while your notebook is unattended.

- ❑ Removable data devices: includes USB disk drives, USB pen drives, USB flash drives, USB MP3 drives, USB memory card readers, IEEE 1394 disk drives and any other removable disk drives that can be mounted as a file system when plugged into the system.
- ❑ Optical drive devices: includes any kind of CD-ROM or DVD-ROM drives.
- ❑ Floppy disk drives: 3.5-inch disks only.

To activate Acer eLock Management, a password must be set at first. Once set, you may apply locks to any of the three kinds of devices. The lock(s) will be set without any reboot necessary, and will remain locked after rebooting, until unlocked.

If you do not set a password, Acer eLock Management will reset back to the initial status with all locks cancelled.

**NOTE: If you lose the password, there is no method to reset it except by reformatting the notebook or taking the notebook to an Acer Customer Service Center.** Be sure to remember or write down the password.

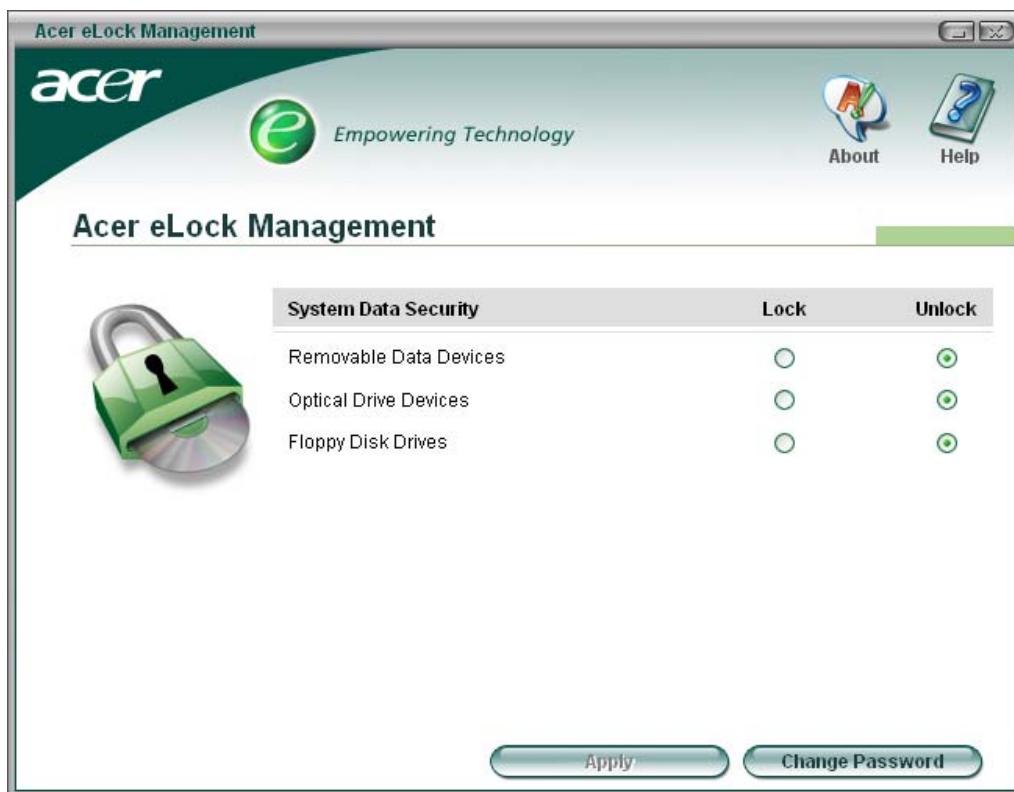

## Acer ePerformance Management

Acer ePerformance Management is a system optimization tool that boosts the performance of the Acer notebook. It provides you with the following options to enhance overall system performance:

- Memory optimization: releases unused memory and checks memory usage.
- Disk optimization: removes unneeded items and files.
- Speed optimization: improves the usability and performance of the Windows XP system.

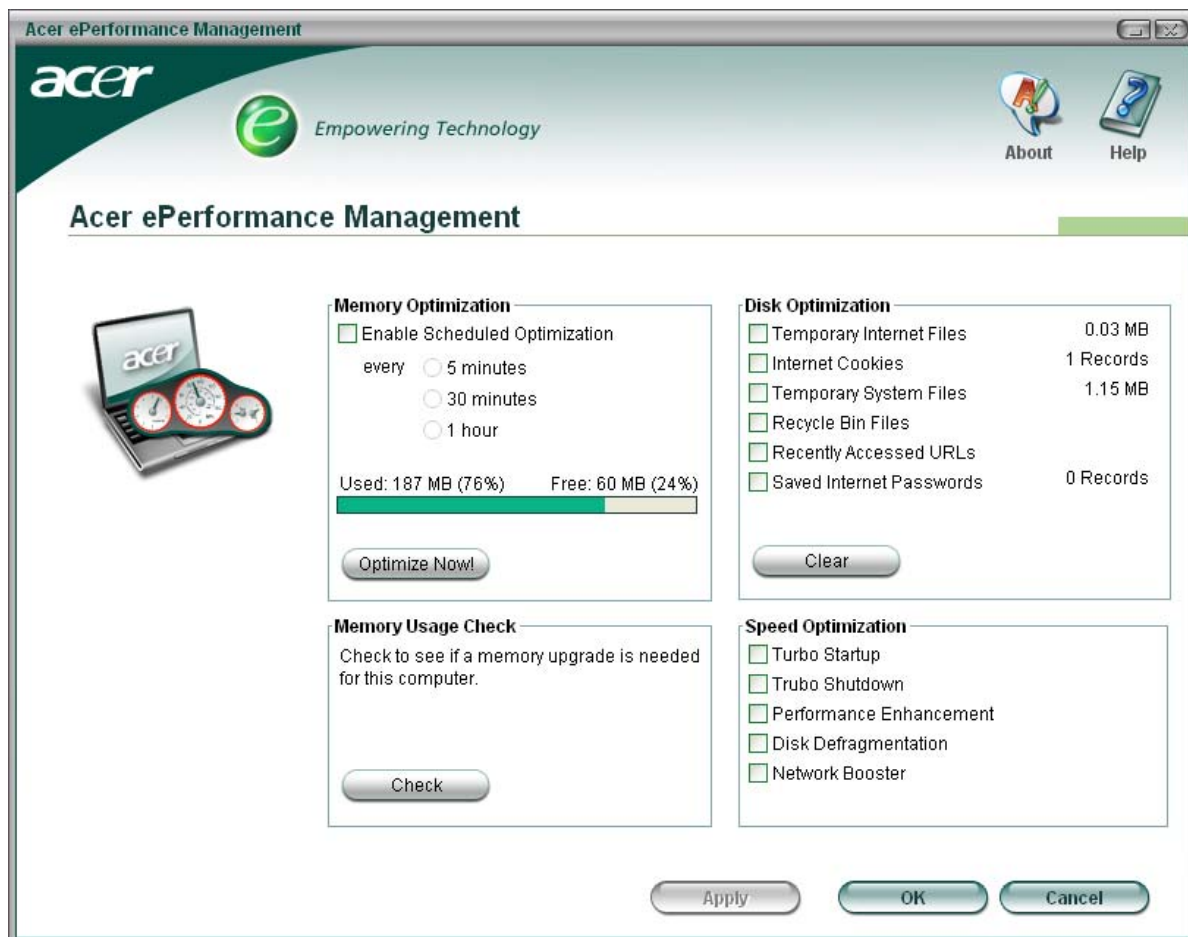

## Acer eRecovery Management

Acer eRecovery Management is a powerful utility with the need for recovery disks provided by the manufacturer. The Acer eRecovery Management utility occupies space in a hidden partition on the system's HDD. User-created backups are stored on D:\ drive. Acer eRecovery Management provides:

- Password protection
- Recovery of applications and drives
- Image or data backup:
  - Backup to HDD (set recovery point)
  - Backup to CD or DVD
- Image or data recovery tools:
  - Recovery from a hidden partition (factory defaults)
  - Recovery from the HDD (most recent user-defined recovery point)
  - Recovery from CD or DVD

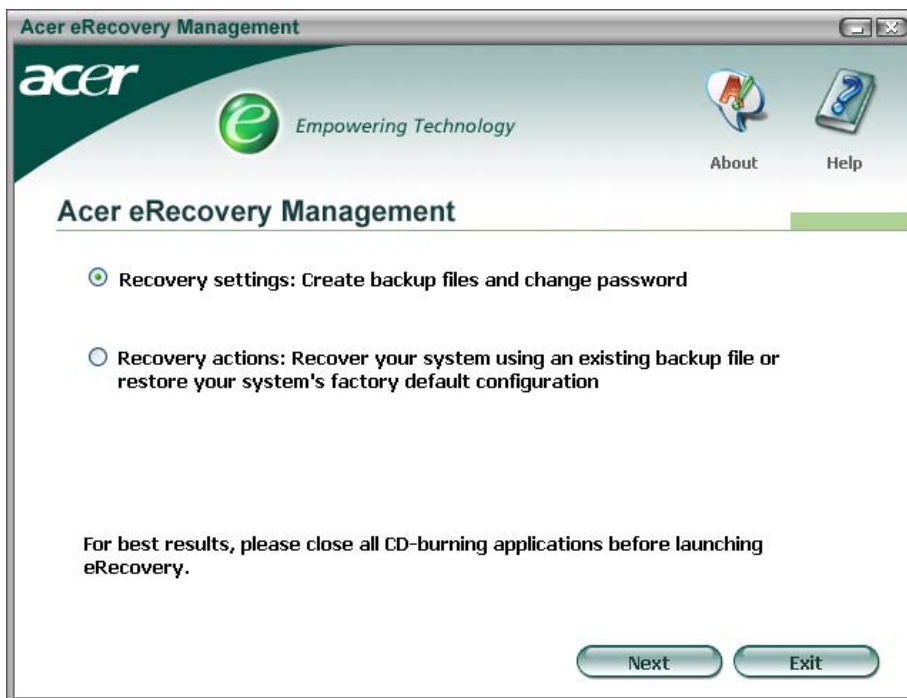

**NOTE:** If the computer did not come with a Recovery CD or System CD, please use Acer eRecovery Management's "System backup to optical disk" feature to burn a backup image to CD or DVD. To ensure the best results when recovering the system using a CD or Acer eRecovery Management, detach all peripherals (except external Acer ODD, if equipped), including the Acer ezDock.



## Acer eSettings Management

Acer eSettings Management allows you to inspect hardware specification and to monitor the system health status. Furthermore, Acer eSettings Management enables you to optimize your Windows operating system, so your computer runs faster, smoother and better.

- ❑ Provides a simple graphical user interface for navigating through the program effortlessly.
- ❑ Displays general system status and advanced monitoring for power users.
- ❑ Logs when a hardware component has been removed or replaced.
- ❑ Permits you to migrate personal settings.
- ❑ Keeps a history log of all alerts that were previously issued.



## Acer eNet Management

Acer eNet Management helps you to quickly and easily connect to both wired and wireless networks in a variety of locations. To access this utility, either click on the “Acer eNet Management” icon on the notebook, or start the program from the Start menu. You also have the option to set Acer eNet Management to start automatically when you boot up the PC.

Acer eNet Management automatically detects the best settings for a new location, while offering you the freedom to manually adjust the settings to match your needs, simply by right clicking on the icon in the task bar.

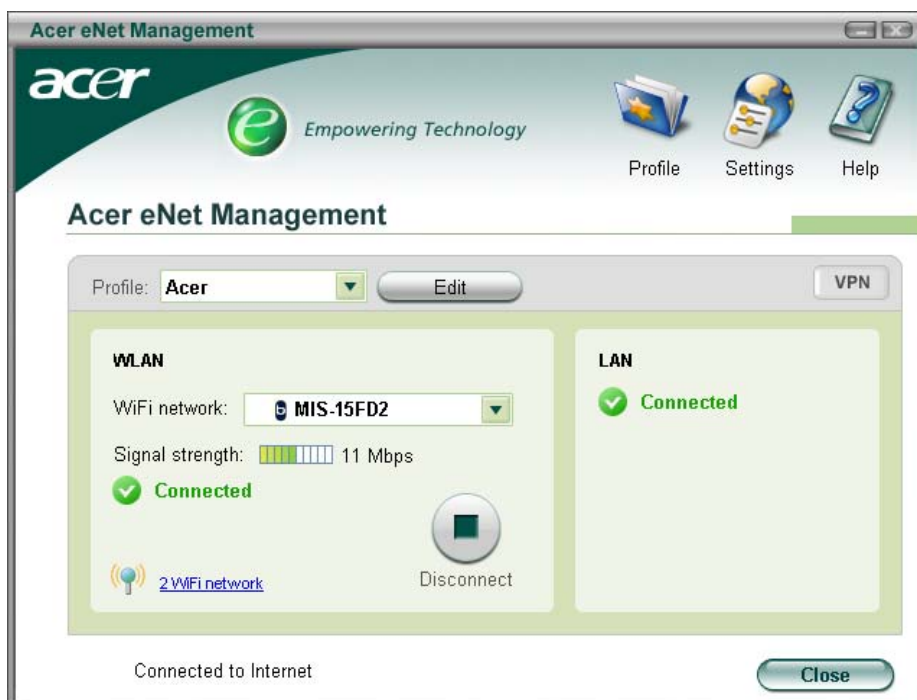

Acer eNet Management can save network settings for a location to a profile, and automatically apply the appropriate profile when you move from one location to another. The settings stored include network connection settings (IP and DNS settings, wireless AP details, etc.), as well as default printer settings. The security and safety concerns mean that Acer eNet Management does not store username and password information.

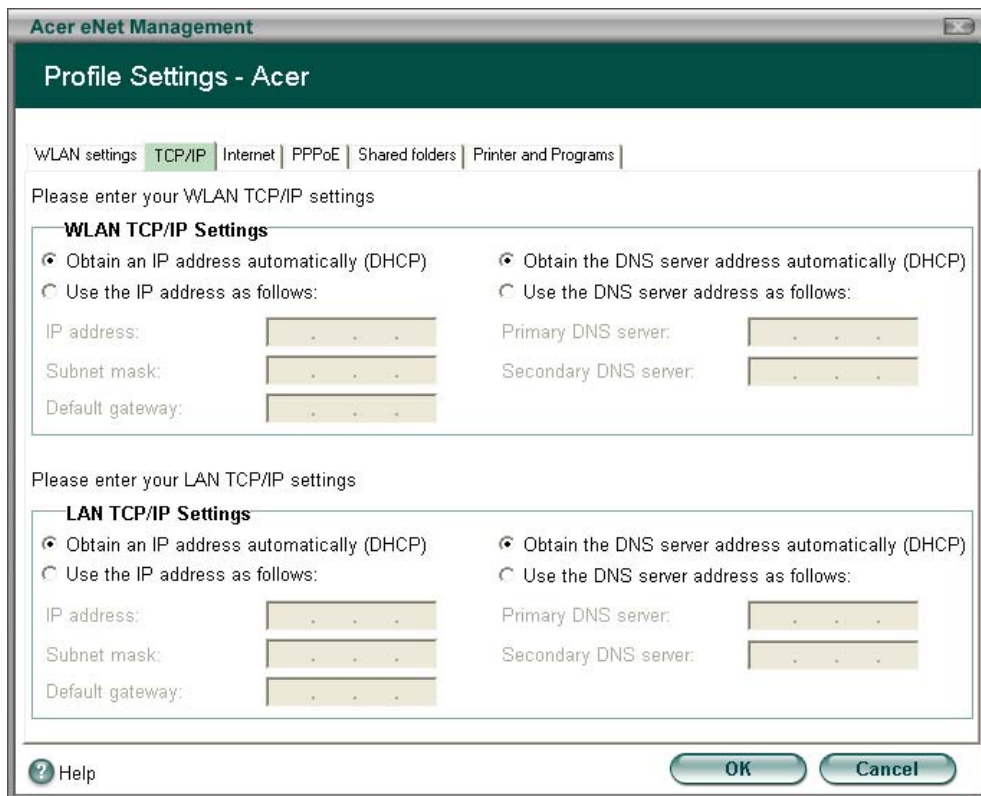

## Acer ePower Management

Acer ePower Management features a straightforward user interface. To launch it, select Acer ePower Management from the Empowering Technology interface, or double click the Acer ePower Management icon in the task tray.

### AC mode

The default setting is “Maximum Performance.” You can adjust CPU speed, LCD brightness and other settings, or click on buttons to turn the following functions on or off: Wireless LAN, Bluetooth, CardBus, Memory Card, Audio, and Wired LAN.

### DC mode

To suit your usage, there are four pre-defined profiles: Entertainment, Presentation, Word Processing, and Maximum Battery. Or, you can define up to three of your own profiles.

### Battery status

For real-time battery life estimates based on current usage, refer to the panel on the lower left side of the window.

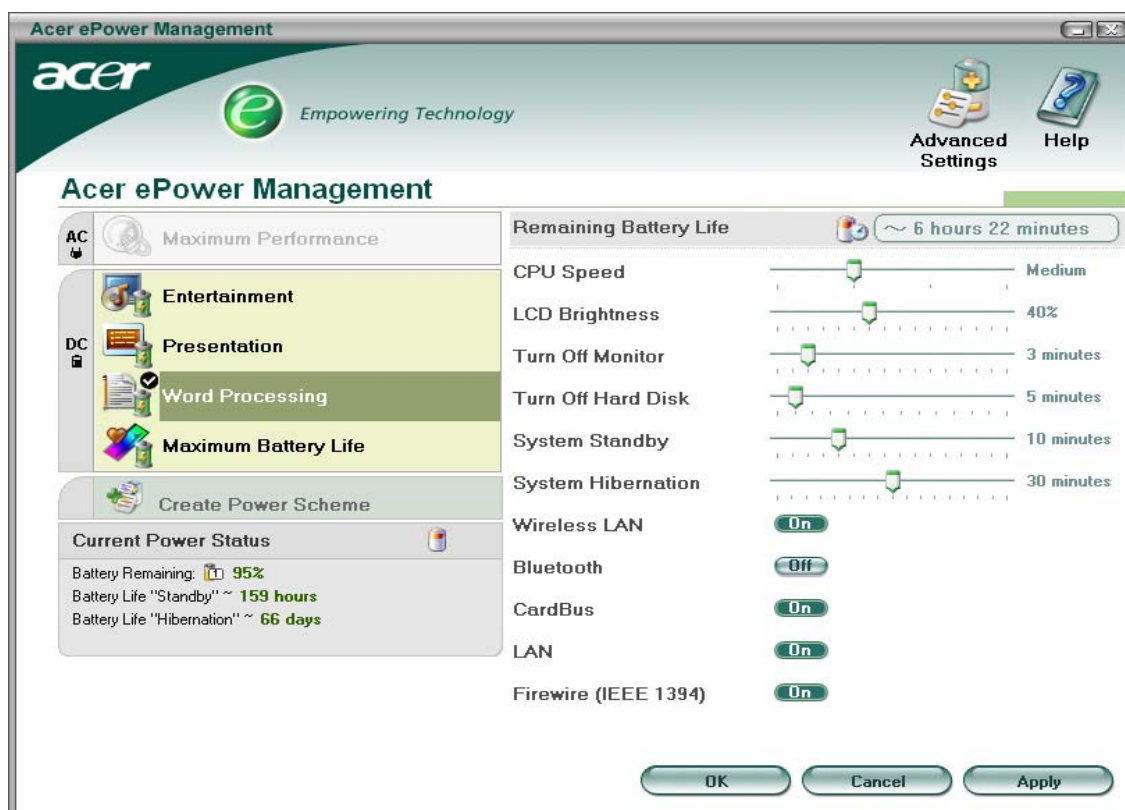

You can also click “Advanced settings” to:

- Set alarms.
- Reload factory defaults.
- Select what actions will be taken when the cover is closed, and set passwords for accessing to the system after Hibernation or Stand-by.

- View information about Acer ePower Management.

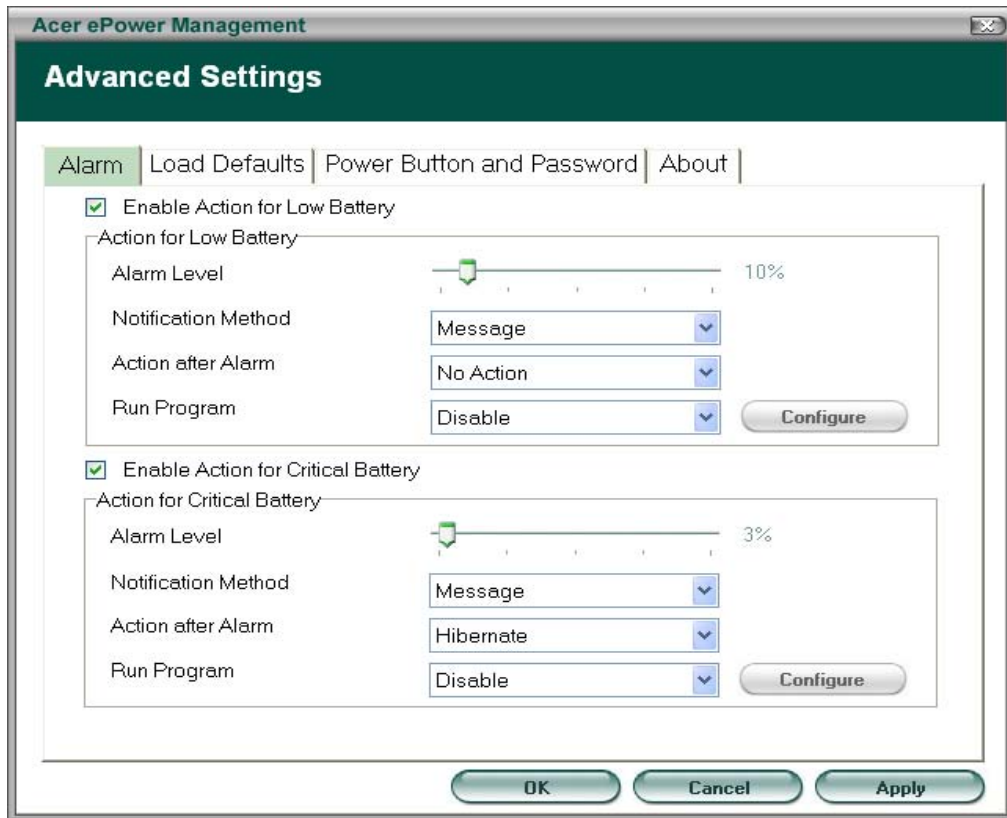

---

## Acer ePresentation Management

Acer ePresentation Management lets you select from two of the most common projector resolution: XGA and SVGA.

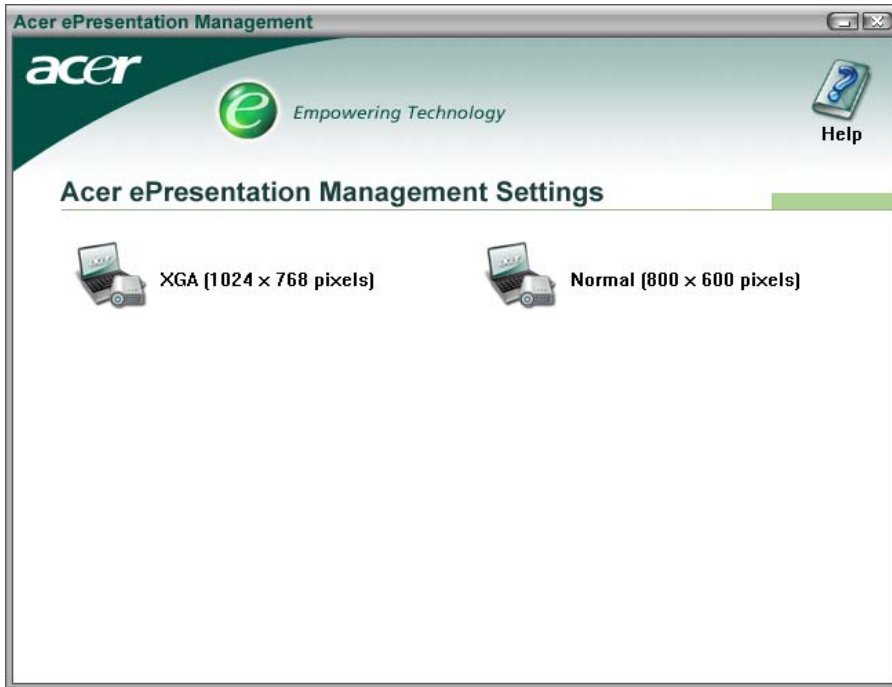

## Acer OrbiCam

The Acer OrbiCam is a 1.3 megapixel CMOS camera appropriately mounted on the top of the LCD panel. The camera's 225-degree ergonomic rotation allows you to capture high-resolution photos or videos up front or at the back of the LCD panel. The Acer OrbiCam fully supports the Acer Video Conference technology so that you can transmit the best video quality over an instant messenger service.

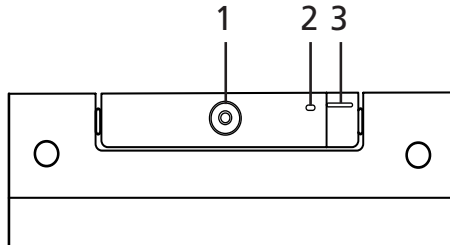

No.	Item
1	Lens
2	Power indicator
3	Rubber grip (selected models only)

### Rotating the Acer Orbicam

The Acer OrbiCam rotates 225 degrees counterclockwise to achieve the desired angle. Refer to the illustrations below:

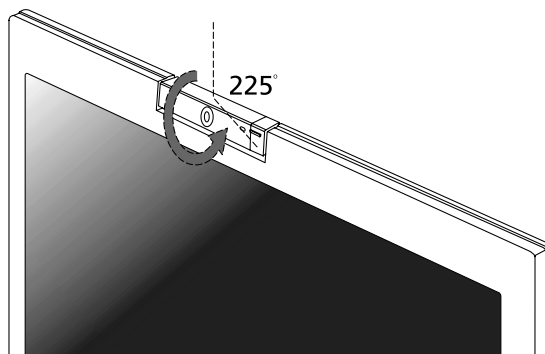

For your convenience, the camera snaps 45 degrees to match the position of your face in front or back of the LCD panel.

**NOTE:** Do not rotate the camera clockwise to prevent it from the damage.

---

## Launching the Acer OrbiCam

To launch the Acer OrbiCam, double click on the Acer OrbiCam icon on the screen. or Click Start > All programs > Acer > Acer OrbiCam. The Acer OrbiCam capture windows window appears as below:



## Changing the Acer OrbiCam settings

### Resolution

To change the capture resolution, click the displayed resolution at the bottom right corner of the capture window, then select the desired resolution. Setting the camera resolution to 640 x 480 or larger does not change the capture window size.

### Options

Click Options to display the Window, Preview, and Folder tabs. Use the options to change the capture window size, preview settings, and the folder for captured photos or videos.

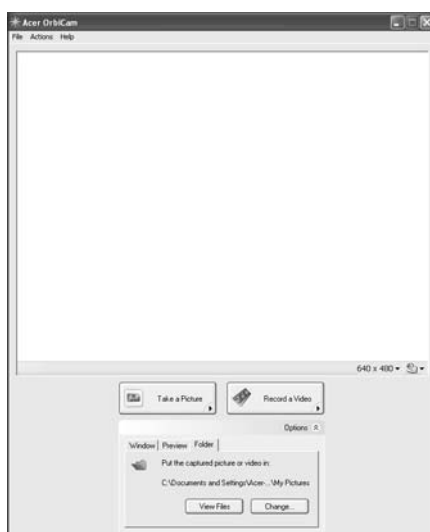



---

## Camera Settings

- Basic settings: Click the Camera Settings icon on the bottom right corner of the capture display, then select Camera Settings from the pop-up menu. You can adjust the Video, Audio, and Zoom/Face tracking options from this window.



- Capture settings: From the Camera Settings window, click the Driver Settings button. The Properties window will appear.



- Device Settings allows you to change the camera brightness, contrast, hue, saturation, sharpness, etc.
- Advanced Settings allows you to achieve gain control, implement image mirror, select image enhancements and anti-flicker settings, and turn on/off the camera indicator.
- Zoom/Face Track Settings allows you to adjust the zoom level and turn the face tracking feature on or off.

## Capturing photos or videos

To capture a photo or a video clip, rotate the Acer OrbiCam to get the desired angle, then click the Take a Picture or Record a Video button. The Windows Picture and Fax Viewer or the Windows Media Player automatically launches to display or play a preview of the photo/video clip.

**NOTE:** By default, all photos and videos are saved in the My Pictures and My Videos folder.

## Using the Acer OrbiCam as webcam

The Acer OrbiCam is automatically selected as the capture device of any instant messenger (IM) application. To use the Acer OrbiCam as a webcam, open the IM service, then select the video/webcam feature. You can now broadcast from your location to an IM partner anywhere in the world.

---

## Enabling the Acer VisageON

The Acer VisageON technology comes with two features: Face tracking and Video effects (selected models only). The Face Tracking feature tracks your head movement and automatically centers your face in the capture window. The video effects feature allows you to select and apply an effect to your video transmissions.

**NOTE:** The face tracking feature is not capable of centering your face beyond the capture window frame. Minimal head movements are tracked more efficiently.

To enable the Acer VisageON:

1. Right click on this icon, then select VisageON from the pop-up menu.

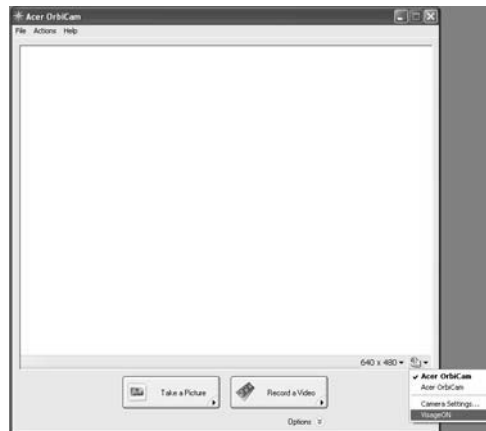

The VisageON window appears as below:



2. Select and apply a video effect in the left section of the VisageON window. Change the face tracking settings and options in the right section.

## Using the face tracking feature

To use the face tracking feature:

1. Click the left icon down arrow button, then select Single User or Multiple Users from the pop-up menu. For multiple users, the face tracking feature automatically centers all the users' face in the capture window, otherwise the utility centers the face of the user closest to the camera.



2. Click the right icon to zoom in/out or reset the current view.

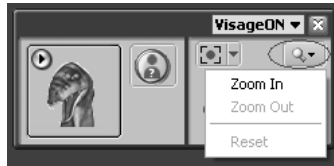

3. Click VisageON to display a menu that allows to change the configuration of the camera, face tracking and video effects settings.

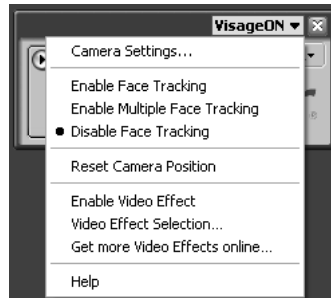

### Using video effects (selected models only)

The Video Settings section allows you to select an avatar or accessory video effect from the list. To select an effect:

1. Click the encircled icon to display the available video effects. The Video Effect Selection window appears as below:



- 
2. Click on a video effect to use. The selected effect appears in the video effects section of the VisageON window.

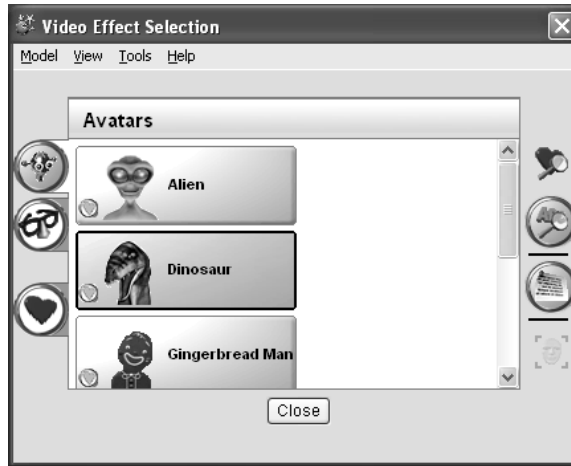

**NOTE:** When using avatars, you may have to calibrate the face points to achieve better tracking. Follow screen instructions in the VisageON to continue.

**NOTE:** You may use video effects when using the camera for IM chat/video sessions or call conferences.

# Using the System Utilities

**NOTE:** The system utilities work under Microsoft Windows XP only.

## Acer GridVista (dual-display compatible)

**NOTE:** This feature is only available on certain models.

To enable the dual monitor feature of the notebook, first ensure that the second monitor is connected, then select Start, Control Panel, Display and click on Settings. Select the secondary monitor (**2**) icon in the display box and then click the check box Extend my windows desktop onto this monitor. Finally, click Apply to confirm the new settings and click OK to complete the process.

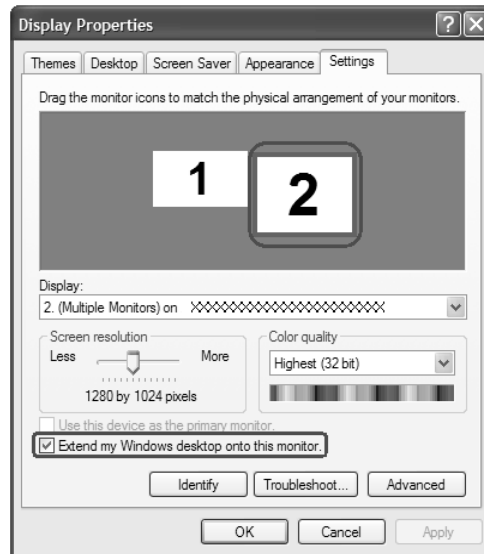

Acer GridVista is a handy utility that offers four pre-defined display settings so you can view multiple windows on the same screen. To access this function, please go to Start > All Programs and click on Acer GridVista. You may choose any one of the four display settings indicated below:



Acer GridVista is dual-display compatible, allowing two displays to be partitioned independently. Acer GridVista is simple to set up:

1. Run Acer GridVista and select your preferred screen configuration for each display from the task bar.
2. Drag and drop each window into the appropriate grid.
3. Enjoy the convenience of a well-organized desktop.

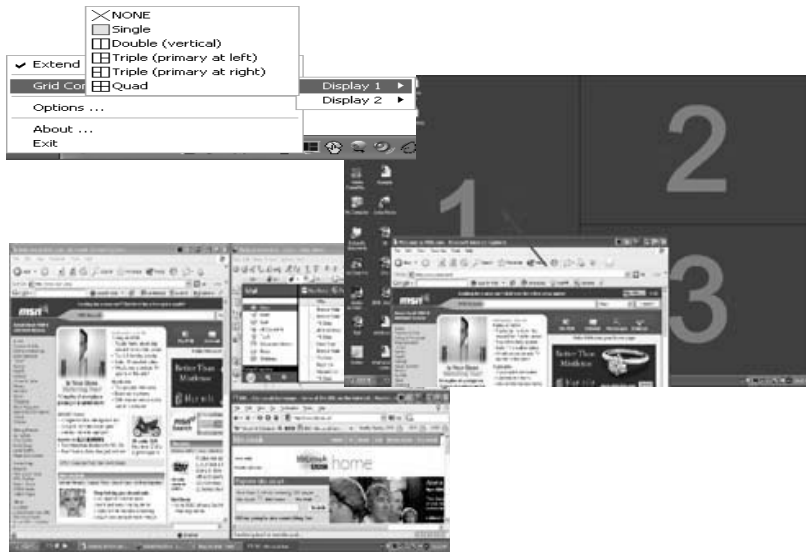

**NOTE:** Please ensure that the resolution setting of the second monitor is set to the manufacturer's recommended value.

## Launch Manager

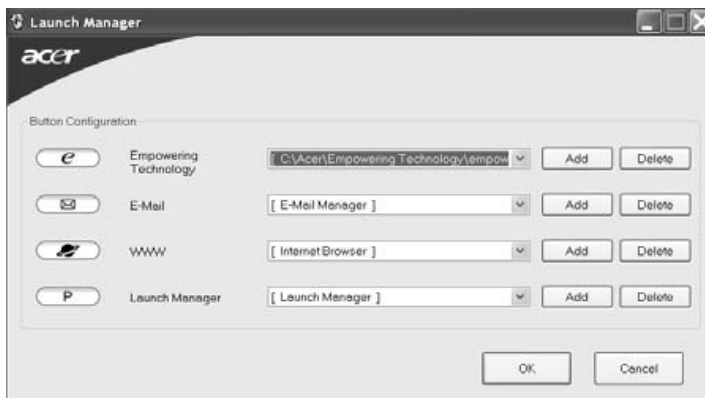

Launch Manager allows you to set the four easy-launch buttons located above the keyboard. You can access the Launch Manager by clicking on Start > All Programs > Launch Manager to start the application.

# Norton AntiVirus

Norton AntiVirus is an anti-virus software that finds and repairs infected files, and protects against viruses to keep your computer data safe and secure.

## How do I check for viruses?

A Full System Scan scans all files on your computer. To perform a system scan:

1. Start Norton Antivirus: Double click on the **Norton AntiVirus** Icon on the desktop or click on the **Start** menu in the Windows task bar, highlight **Programs**, and select **Norton Antivirus**.
2. In the Norton Antivirus main window, click **Scans**.

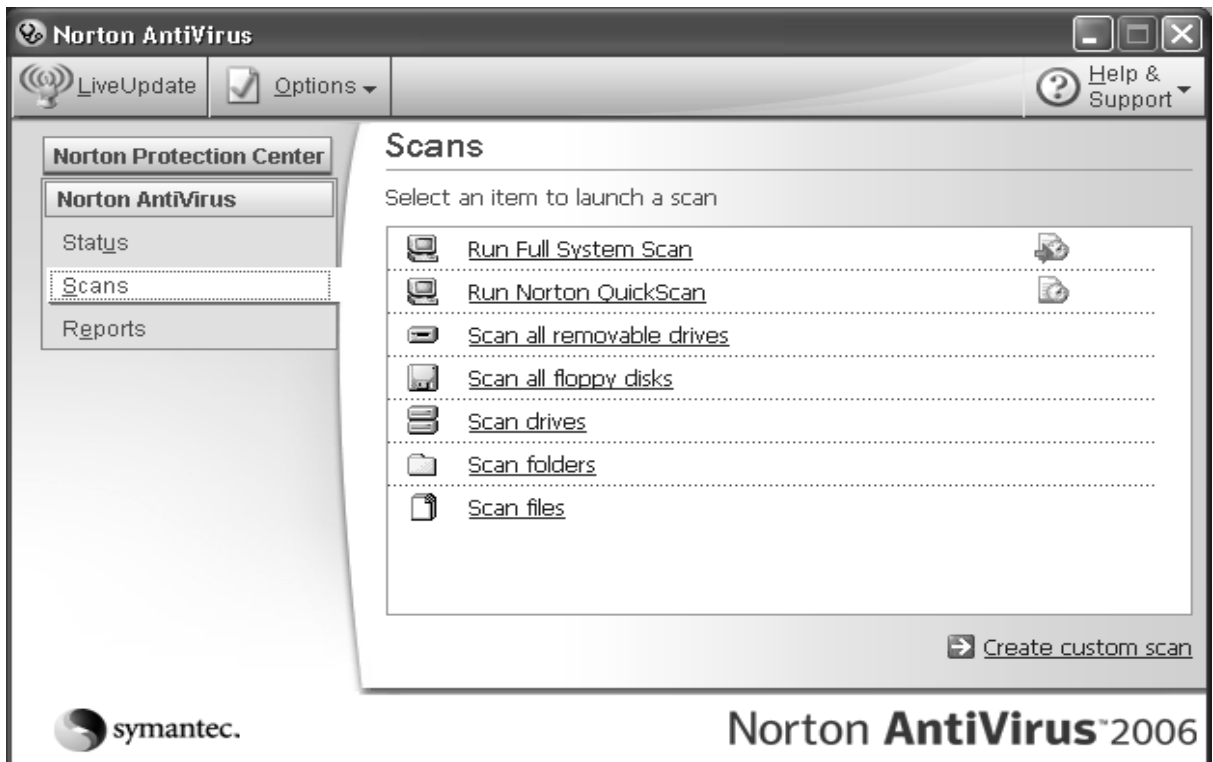

3. In the **Scans** panel, click **Run Full System Scan**.
4. When the scan is complete, a scan summary appears. Click **Finished**.

You can schedule customized virus scans that run unattended on specific dates and times or at periodic intervals. If you are using the computer when the scheduled scan begins, it runs in the background so that you do not have to stop working.

For more information, please refer to the Norton AntiVirus Help menu.

# Hardware Specification and Configuration

## Processor

Item	Specification
CPU type	Intel® Core™ Duo processor T2300/T2400/T2500/T2600 Intel® Celeron® M processor 410/420/430
Package	Micro-FCPGA
Core voltage	1.2875V (highest frequency mode) to 0.8375V (low frequency mode)
Feature	Intel® Core™ Duo processor: Intel® Architecture with SpeedStep Technology
Bus speed	533/667 FSB operation
On-die second (L2) cache	2048KB

## System Board Major Chips

Item	Specification
System core logic	945GM/945PM/940GML + ICH7M
Super I/O controller	ICH7M LPC interface
Audio controller	Codec ALC883
Video controller	<ul style="list-style-type: none"> <li>UMA for 945GM and 940GML</li> <li>Nvidia G72MV</li> </ul>
HDD controller	ICH7M
Keyboard controller	ENE KB3910
PCMCIA controller	TI7412 (with card reader and 1394 support)
soDIMM controller	945GM/945PM/940GML

## Hard Disk Drive

Seagate				
Model	ST9120821A ST9120824A	ST9100824A ST9100825A	ST98823A ST980829A	ST96812A
Drive Specification				
Formatted Gbytes (512 bytes/sector)	120	100	80	60
Physical read/write head	4	4	3	3
Discs	2	2	2	2
Spindle Speed (RPM)	4200 (ST9120824A, ST9100825A, ST980829A) 5400 (ST9120821A, ST9100824A, ST98823A, ST96812A)			
Internal transfer rate (Mbytes/sec. max.)	56.25 (ST9120824A, ST9100825A, ST980829A) 48.25 (ST9120821A, ST9100824A, ST98823A, ST96812A)			
I/O data transfer rate (Mbytes/sec. max.)	100			
ATA data transfer mode supported	PIO modes 0-4; Multiword DMA modes 0-2; Ultra DMA modes 0-5			
Bytes per sector	512			
Average latency (msec)	5.6			



## Hard Disk Drive

Seagate	
Average seek, read (msec. typical)	12.5
Average seek, write (msec. typical)	14.5
Cache buffer	8 Mbytes
Interface	Serial ATA
Startup current (typical, peak)	+5V: 1.1 amps
Ambient temperature	5 to 55°C (operating), -40 to 70°C (nonoperating)
Temperature gradient (°C per hour max.)	20°C (operating), 30°C (nonoperating)
Relative humidity	5% to 90% (operating), 5% to 95% (nonoperating)
Relative humidity gradient	30% per hour max.
Drive acoustics, sound power (bels) idle	2.4 (typical), 2.6 (max)
Shock, operating (Gs max. at 0.5 msec.)	250
Shock, nonoperating (Gs max. at 2 msec.)	800
Vibration, operating	1.0 G (0 to peak, 5-500 Hz)
Vibration, nonoperating	5 Gs (0 to peak, 5-500 Hz)
Nonrecoverable read errors	1 per 10 <sup>14</sup> bits read, max.
Seek power (typical)	2.20 watts
Read/write power (typical)	Read: 1.90 watts; Write: 2.30 watts
Idle mode, lower power (typical)	0.80 watts
Standby mode	0.28 watts
Sleep mode	0.28 watts
Voltage tolerance	+5.0V +/- 5%

## BIOS

Item	Description
BIOS vendor	Phoenix
System BIOS version	V1.00
Feature	<ul style="list-style-type: none"> <li>• Suspend to RAM (S3) / Disk (S4)</li> <li>• Support boot option: HDD / Removable device (media bay device) / all USB ports</li> <li>• Support SMBIOS 2.3, PCI2.2, WFM2.0</li> <li>• ACPI 2.0/3.0 compliance with Intel Speedstep Support C1, C2, C3, C4 and S3, S4 for mobile CPU</li> <li>• Wake on LAN from S3</li> <li>• Wake on LAN from S4 in AC mode</li> <li>• Package: 40-pin TSOP</li> <li>• ROM type: one MB CMOS Boot block Flash Memory</li> </ul>

## System Memory

Item	Description
Chipset	945GM/945PM/940GML
Feature	<ul style="list-style-type: none"><li>• DDR2 400/533/667 MHz SDRAM memory interface design</li><li>• Two DDR SODIMM slots</li><li>• Maximum memory up to 4GB (with two 2GB SODIMM)</li><li>• Dual Channel</li></ul>

## VGA

Item	UMA	Discrete
Chip	945GM/940GML	Nvidia G72MV
VRAM	up to 128MB	up to 256MB

## PCMCIA

Item	Description
PCMCIA controller	TI7412
Card type support	Type II
Number of slot	One
Feature	Five-in-one Card Reader: Memory Stick (MS), Memory Stick Pro (MS PRO), MultiMediaCard (MMC), Secure Digital (SD) and xD-Picture Card (xD).

## Audio

Item	Description
Audio controller	Realtek ALC833 Azadia Codec
Feature	<ul style="list-style-type: none"><li>• Built-in</li><li>• Stereo</li><li>• SNR &gt; 85, high-performance DACs with 95dB SNR (A-Weighting), ADCs with 85dB SNR (A-Weighting)</li><li>• Internal Microphone</li><li>• Two speakers, at least 1.5W / 30cc for each</li><li>• 2* digital microphone array</li><li>• VoIP function support</li><li>• Universal jack function support</li></ul>

## LAN

Item	Description
LAN controller	Realtek RTL8111B
Feature	<ul style="list-style-type: none"><li>• 10 / 100 / 1000 Mbps PCI LAN</li><li>• Jumbo frame support</li><li>• WOL from S5 support</li><li>• File deployment support</li></ul>

## LAN

Item	Description
Connector type	RJ-45

## Wireless LAN

Item	Description
Card type	Mini-PCI
Mode	<ul style="list-style-type: none"><li>• 802.11a/b/g</li><li>• 802.11b/g</li><li>• Built-in two antenna (placed on the top of LCD on the side of LCD latch, the wire of antenna can not be placed under the panel)</li></ul>
Support	Wi-Fi, WPA2, WMM, CCX V3/V4

## Modem

Item	Description
Controller	ICH7M
Data modem data baud rate (bps)	56K
Modem/bluetooth protocol supported	<ul style="list-style-type: none"><li>• V.90/V.92 AC-Link modem with PTT approval</li><li>• Wake-on-Ring ready</li><li>• CISPR22 application</li></ul>
Connector type	RJ-11

## Keyboard

Item	Description
Controller	ENE KB3910
Model name	New Acer Ergo Keyboard
Feature	<ul style="list-style-type: none"><li>• 105 / 106 keys standard keyboard</li><li>• Touch pad with 4-way integrated scroll button</li><li>• Windows keys and application keys support</li><li>• Standard pitch, 2.5 mm travel length</li><li>• Hotkey controls</li><li>• Embedded numeric keypad</li><li>• Multi-language support</li><li>• Spill-proof</li><li>• Four easy-launch buttons: Internet browser, E-mail with LED, Acer Empowering, one user-programmable button</li></ul>

## Battery

Item	Specification
Vendor & model name	Panasonic / Sanyo / Sony
Battery Type	Li-Ion

## Battery

Item	Specification
Pack capacity	8-cell: 2400 mAh 6-cell: 2000 mAh

## System Power Management

Legacy Mode	ACPI Mode
Off	<ul style="list-style-type: none"> <li>• Mech. Off (G3): All devices in the system are turned off completely.</li> <li>• Soft Off: (G2/S5): All devices in the system are turned off completely by OS shutdown.</li> </ul>
On	<ul style="list-style-type: none"> <li>• Working (G0/S0): Individual devices such as the CPU and hard disk may be power-managed in this state.</li> <li>• <b>S3</b> Sleeping State: CPU set power down, VGA suspend, PCMCIA suspend, Audio power down, HDD power down, CD-ROM power down, Super I/O low power mode.</li> <li>• <b>S4</b> Sleeping State: It is also called hibernation state. The system saves all system setting and data onto disk before the whole system is powered off.</li> </ul>

## LCD

Item	Specification			
Vendor and Model name	Samsung LTN170WX-L05-H	QDI QD17TL02-06	AUO B170PW03 V4	LG LP171WP4-TL02
Screen Diagonal (mm)	17.1" WXGA	17.1" WXGA	17.1" WXGA	17.1" WXGA
Active area	367.20 (W) x 229.50 (H)	367.20 (W) x 229.50 (H)	367.20 (W) x 229.50 (H)	367.20 (W) x 232.9 (H)
Display resolution	1440 x 3 (RGB) x 900	1440 x 3 (RGB) x 900	1440 x 3 (RGB) x 900	1440 x 3 (RGB) x 900
Display mode	normally white	normally white	normally white	normally white
Surface treatment	non-glare type (1) glare type (H)	hard coating (3H) glare type	glare type	glare type
Pixel arrangement	RGB vertical stripe	RGB vertical stripe	RGB vertical stripe	RGB vertical stripe
Pixel pitch (mm)	0.255 (per one triad) x 0.255	0.255 (per one triad) x 0.255	0.255 (per one triad) x 0.255	0.255 (per one triad) x 0.255
Typical white luminance (cd/m <sup>2</sup> ) also called brightness	200 (typical)	200 (center typical)	200 (typical)	200 (typical)
Contrast ratio	350 (typical)	300 : 1 (Min)	300 : 1 (typical)	350 (Min)
Respond time (optical rise time + fall time) (msec.)	25 (typical) 35 (max.)	25 (typical)	16 (typical)	25 (typical)
Normal input voltage of power supply	+3.3V (typical)	+3.3V (typical)	+3.3V (typical)	+3.3V (typical)

## LCD

Item	Specification			
Power consumption (watt)	4.320 (typical)	4.7 (typical)	8 (max.)	4.78 (typical)
Weight	750g	750g	700g	670g
Physical size (mm)	382.7 (W) x 245 (V) x 7.0 (T)	382.7 (H) x 245.1 (V) x 7.0 (T)	382.2 (W) x 244.5 (H) x 6.6 (D)	382.2 (W) x 244.5 (H) x 6.5 (D)
Electrical interface	2 channel LVDS	2 channel LVDS	2 channel LVDS	2 channel LVDS
Color support	Native 262K colors	Native 262K colors	Native 262K colors	Native 262K colors

## AC Adaptor

Item	Specification	
Model name	LiteOn PA-1900-04AW	Delta 90W ADP-90SB BBAA
Input feature		
Rated voltage	for 100Vac or 240Vac input AC voltage	for 100Vac or 240Vac input AC voltage
Input voltage range	from 90Vac to 264Vac	from 90Vac to 265Vac
Rated frequency	for 50Hz or 60Hz	for 50Hz or 60Hz
Frequency range	from 47Hz to 63Hz	from 47Hz to 63Hz
Steady AC current	less than 1.5A rms at 100Vac input and maximum load	less than 1.5A rms at 100Vac input and maximum load
Output feature		
Rated voltage	19V	19V
Voltage range	18.05V to 20V	from 18.2V to 19.8V
Rated power	90 W	90 W
Output ripple and noise	less than 300mVp-p	less than 300mVp-p
Turn on delay time	within two seconds at 115 Vac input voltage	within two seconds at 115 Vac input voltage
Temperature	Operating: 0 to 40°C Non-operating: -31 to 60°C	Operating: 0 to 40°C Non-operating: -31 to 60°C

## 24X Combo Drive Interface

Item	Specification	
Vendor & model name	PHILIPS SCB5265	LITEON SSC-2485K
Performance Specification		
Transfer rate (KB/sec.)	Sustained: DVD: Max 10.56Mbytes/sec. CD: 3600Kbytes/sec.	Sustained: DVD: Min 10.15Mbytes/sec. CD: 3500 Kbytes/sec.

Item	Specification	
Access Time (Typical)	DVD: Random Access: 125 ms DVD: Full Stroke: 165ms CD: Random Access:105ms CD: Full Stroke:160ms	DVD: Random Access: 100 ms DVD: Full Stroke: 190ms CD: Random Access:95ms CD: Full Stroke:180ms
Buffer Memory	2MB	2MB
Interface	Compliant to ATA/ATAPI-5	ATA/ATAPI-6, MMC-3 and SFF8090 Ver5, Revision 1.2.
Applicable disc format	DVD (read): DVD 5, 9, 10, 18, DVD-ROM, DVD-Video, DVD-R 3.95G, DVD-R 4.7G, DVD-RW, DVD+R, DVD+RW, Multi-Border DVD-R/DVD-RW, Multi-Session DVD+R, DVD+RW, DVD-RAM CD (write): CD-DA, CD ROM Mode-1, CD-ROM/XA Mode-2 Form-1 and Mode-2 Form-2, CD-I, Video-CD (MPEG-1), CD-Text CD (write): CD-DA, CD-ROM Mode-1, CD-ROM/XA Mode-2 Form-1 and Mode-2, CD-i, Video-CD, CD-Text	CD: CD-DA, CD-ROM Mode-1, CD-ROM XA Mode-2 Form-1 and Form-2, CD-I Ready, Video-CD(MPEG-1), Karaoke-CD, PhotoCD (Multi-Session), Enhance CD, CD extra, I-Trax CD and UDF
Loading mechanism	Load: Manual load	Manual load/DC brushless motor system
Power Requirement	Max. 1300mA	Max. 1200mA
Input Voltage	5 V +/- 5% (Operating)	5 V +/- 5% (Operating)

### 8X DVD Dual Interface

Item	Specification
Vendor and model name	PHILIPS SDVD8441
Performance specification	
Transfer rate (KB/sec.)	Sustained: DVD:10.9Mbytes/sec. (Typ) CD: 3650Kbytes/sec. (Typ)
Access time (typical)	DVD: Random Access: 130 ms DVD: Full Stroke: 240ms CD: Random Access:130ms CD: Full Stroke:240ms
Buffer memory	2MB
Interface	ATA/ATAPI-5

Item	Specification
Applicable disc format	DVD (read): DVD-ROM 5,9,10,18, DVD-VIDEO, DVD-AUDIO, DVD-R, DVD-R 3.95G, DVD-R MULTI BORDER, DVD-RW, DVD+R, DVD+R DL, DVD+R MULTI-SESSION, DVD+RW CD (read): CD-DA, CD-ROM Mode-1, CD-ROM/XA Mode-2 Form-1 Form-2, CD-I, CD-I Bridge, Video-CD(MPEG-1), Karaoke CD, Photo-CD, Enhanced CD, CD Plus, CD Extra, i-trax CD, CD-Text, CD-R, and CD-RW DVD (write): DVD Data & Video CD (write): CD-DA, CD-ROM Mode-1, CD-ROM/XA Mode-2 Form-1 and Mode-2 Form-2, CD-i, Video-CD, CD-Text
Loading mechanism	Load: manual load
Power consumption	Max. 1500 mA
Input voltage	5V +/- 5% (operating)

### 8X Super Multi Interface

Item	Specification		
Vendor and model name	Liteon SSM 8515S	Pioneer DVR-K06RS	Philip SDVD-8821
Performance Specification			
Transfer rate read (KB/sec.)	Sustained: <ul style="list-style-type: none"> <li>DVD: 10.00Mbytes/sec.</li> <li>CD: 3500kbytes/sec.</li> </ul>	Sustained: <ul style="list-style-type: none"> <li>DVD: 10.80Mbytes/sec.</li> <li>CD: 3600kbytes/sec.</li> </ul>	Sustained: <ul style="list-style-type: none"> <li>DVD: 10.90Mbytes/sec.</li> <li>CD: 3650kbytes/sec.</li> </ul>
Access time / Seek time	<ul style="list-style-type: none"> <li>DVD: random access 130ms</li> <li>DVD: full stroke 250ms</li> <li>CD: random access 110ms</li> <li>CD: full stroke 220ms</li> </ul>	<ul style="list-style-type: none"> <li>Access time: DVD 160 msec; CD 150 msec.</li> <li>Random seek time: DVD 150 msec; CD 140 msec.</li> <li>Full stroke seek time: DVD 300 msec; CD 290 msec.</li> </ul>	<ul style="list-style-type: none"> <li>Random access: DVD 130ms; CD 130ms</li> <li>Full stroke: DVD 200ms; CD 240ms</li> </ul>
Buffer memory	2MB	2MB	2MB
Interface	compliant to ATA/ATAPI-6, MMC-4 and SFF8090 Ver5	compliant to SFF8020, SFF8090	compliant to ATA/ATA-5

Item	Specification		
Applicable disc format	CD-DA, CD-ROM Mode-1, CD-ROM/XA Mode-2 Form-1 and Mode-2 Form-2, CD-I, Video-CD (MPEG-1), CD-Text, PhotoCD, Enhance CD, CD extra, I-Trax CD and UDF DVD-ROM, DVD-Video, DVD-Audio, DVD-R single/multi border, DVD+R single/multi session, DVD-RW, DVD+RW, DVD-RAM	KODAK Photo CD single and multi-session, CD Extra (CD PLUS), Video CD, CD text data (read/write), CD-R (read/write), DVD-ROM, DVD-R (read/write), DVD-R DL (read/write), DVD-RW (read/write), DVD+RW (read/write), DVD+R (read/write), DVD+R DL (read/write), DVD+RW (read/write), DVD+RW high speed (read/write), DVD-RAM (read/write)	<ul style="list-style-type: none"> <li>• DVD read: DVD-5, DVD-9, DVD-10, DVD-18, DVD-Video, DVD-Audio, SACD (Hybrid), DVD-R, DVD-R DL, DVD-R 3.95GB, DVD-R Authoring, DVD-R multi-border, DVD-RW, DVD+R, DVD+R DL, DVD+R Multi-session, DVD+RW, DVD-RAM V1.0, DVD-RAM V2.1; CD read: CD-DA, CD-ROM Mode-1, CD-ROM/XA Mode-2 Form-1 and Mode-2 Form-2, CD-i, CD-i Bridge, Video-CD (MPEG-1), Karaoke CD, Photo-CD, Enhanced CD, CD Plus, CD Extra, i-trax CD, CD-Text, CD-R, CD-RW</li> <li>• DVD write: DVD Data, DVD-video; CD write: CD-DA, CD-ROM Mode-1, CD-ROM/XA Mode-2 Form-1 and Mode-2 Form-2, CD-i, Video-CD, CD-text</li> </ul>
Loading mechanism	Load: manual load/DC brushless motor system	N/A	N/A
Power requirement	Max. 1500mA	Max. 1800mA	Max. 1300mA
Input voltage	+5V +/- 5% (operating)	+5V +/- 5% (operating) +5V +/- 8% (start-up)	+5V +/- 5% (operating)



# System Utilities

---

## BIOS Setup Utility

The BIOS Setup Utility is a hardware configuration program built in the BIOS (Basic Input / Output System) of computer. Generally speaking, the computer is already properly configured and optimized, and you do not need to run this utility.

However, if you encounter configuration problems, you may need to run Setup. Otherwise, you can also refer to Chapter 4 Troubleshooting when problem arises.

### Invoking BIOS Setup

To activate the BIOS Utility, press **m** during POST (when “Press <F2> to enter Setup” message is prompted on the left-bottom side of the screen).

There are six prime items in the BIOS Setup Utility. They are Information, Main, Advanced, Security, Boot and Exit. In the coming pages, we will explain the BIOS Setup Utility by item.

Part	Description
Information	Display the system informations.
Main	Allows the user to specify standard IBM PC AT system parameters.
Security	Provides security setting of the system.
Boot	Allows the user to specify the boot options.
Exit	Allows the user to save CMOS setting and exit Setup.

**NOTE:** During setup, all Fn function keys and power saving function are disabled.

## Information

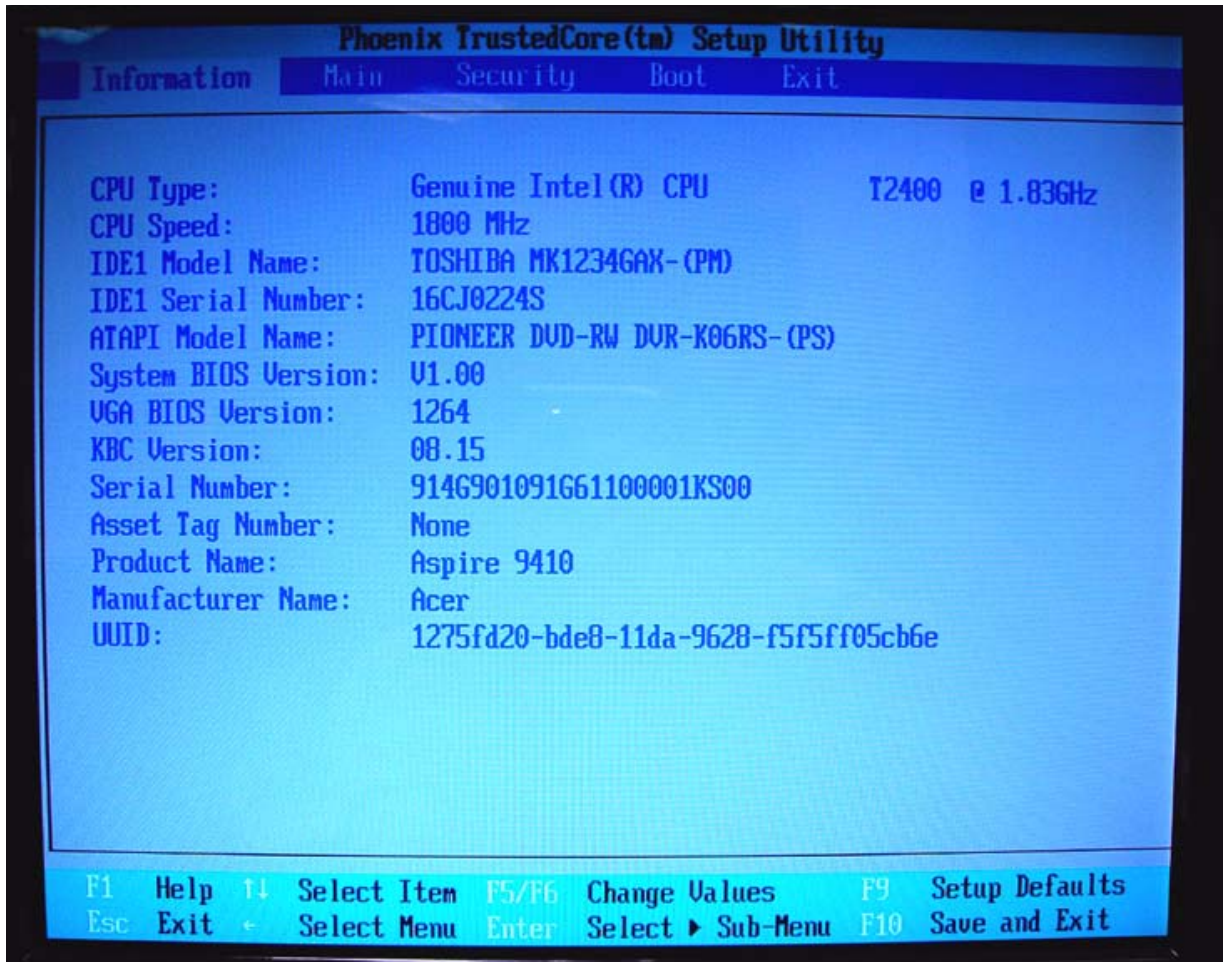

- CPU type: This item will show the CPU information of the system.
- CPU speed: This item will show the COU clock speed.
- IDE1 model name: This item will show the model name of HDD installed on primary IDE master. The hard disk model name is automatically detected by the system. If there is no hard disk present or unknown type, "None" should be shown on this field.
- IDE1 serial number: This item will show the serial number of HDD installed on Primary IDE master. If no hard disk or other devices are installed on primary IDE master, it will display a blank line.
- System BIOS version: This field reports BIOS version of the system.
- KBC version: This field reports keyboard controller version of the system.
- Serial Number: This item is the serial number of the system.
- Asset Tag Number: This item is the asset tag number of the system.
- UUID: It shows only when an internal LAN device is available.

# Main

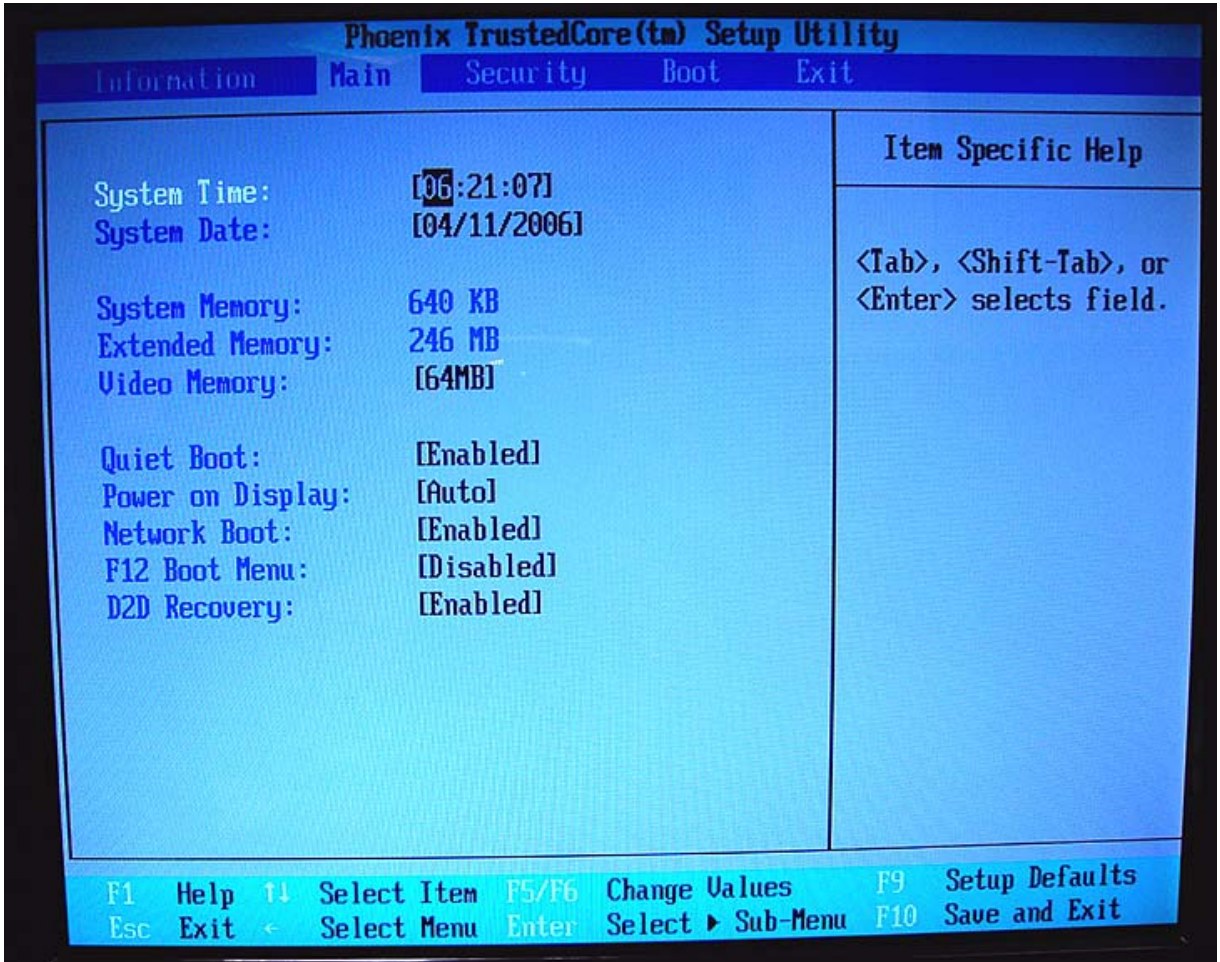

- System Time and System Date:  
The hours are displayed with 24-hour format. The changes in these two items take effect immediately.
- System Memory:  
This item reports the memory size of system base memory. The size is fixed to 640KB.
- Extended Memory:  
It reports the memory size of the extended memory in the system. The extended memory size is equal to total memory size (one MB).
- Video Memory:  
It indicates the video memory size.
- Quiet Boot:
  - Enabled: Customer Logo is displayed, and Summary Screen is disabled.
  - Disabled: Customer Logo is displayed, and Summary Screen is enabled.
- Power on Display:
  - Auto: During power on process, the system will detect if any display device is connected on external video port. If any external display device is connected, the power on display will be only in CRT (or projector) mode. Otherwise, it will be in LCD mode.
  - Both: Both the integrated LCD and the external video port (for an external CRT or projector)

---

will be enabled simultaneously.

❑ Network Boot:

It permits the users to boot from network.

❑ F12 Boot Menu:

- Enabled: When it is enabled, the users can modify device boot priority by pressing <F12> during POST.

- Disabled: When it is not enabled, device boot priority will not be adjustable during POST.

The boot device change is only for one-time change. In other words, when the system is rebooted, the boot device sequence will be the same as the one defined in the BIOS setup (Boot option).

❑ D2D Recovery:

It allows the users to enable or disable the disk-to-disk recovery.

# Security

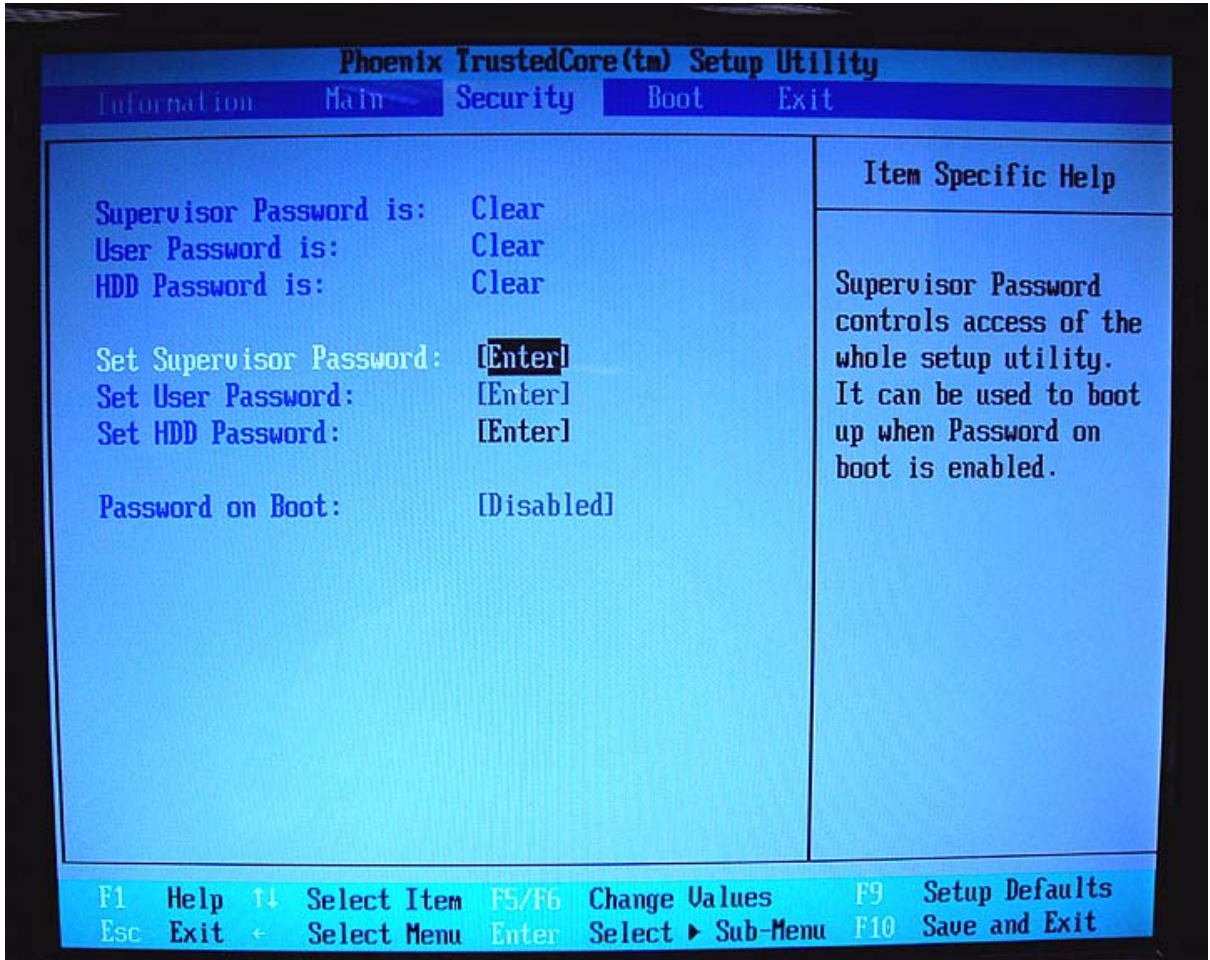

The system supports three levels of password protection. The password support consists of a Supervisor Password, User Password, and Hard Disk Password. All the passwords are stored in a non-volatile storage device (EEPROM).

□ Password Policy:

All the passwords will obey the following rules:

- All the passwords can be set or cleared in BIOS Setup Security screen.
- The password entry consists of eight alphanumeric characters. At least one character must be assigned.
- The valid keys are listed in the table below:

Symbol Character	Symbol Name
A-Z	letters A to Z (not case sensitive)
0-9	numerical characters
-	dash
=	equal sign
[	left bracket
]	right bracket

Symbol Character	Symbol Name
.	period
,	comma
;	semi-colon
/	slash
\	back slash

- The users can not change or remove password during resuming from S4.
- **The max. number of times to retry the password is limited to three.**

❑ Supervisor Password:

Supervisor Password controls the access of the whole BIOS Setup Utility. If the Supervisor Password is set, the system will pop up the password dialog box to ask for the password when the users press <F2> for entering BIOS Setup Utility.

If the Supervisor Password is set and Password on boot is enabled, the system will pop up the password dialog box to ask for the password when the system is powered on or resumes for S4 state.

**If the users fail three times consecutively in password verification, the system will be hung up and the users need to manually power off the system.**

❑ User Password:

If the User Password is set, the system will pop up the password dialog box to ask for the password when the users press <F2> for entering BIOS Setup Utility.

If the Supervisor Password is not set at first, the User Password can not be set. If the Supervisor Password is cleared, the User Password will be cleared, too.

If the User Password is set and Password on boot is enabled, the system will pop up the password dialog box to ask for the password when the system is powered on or resumes for S4 state.

**If the users fail three times consecutively in password verification, the system will be hung up and the users need to manually power off the system.**

❑ Set Supervisor Password / User Password:

1. Highlight the item and press “Enter”, a dialog box will be shown to ask the users to enter new password and confirm new password.
2. If the users want to reset password, a current password will be required to be tapped in at first. If the current password is correct, the users are permitted to enter new password and confirm new password for verification. If the verification is OK, the password setting will be complete after the users press “Enter”.
3. If the password entered does not match the current password, a dialog box will be shown to ask to re-enter the password.

❑ Set HDD Password: When shown as “Locked”, the hard drive password currently can not be changed or disabled. To change or disable it, turn off the system and enter Setup immediately after turning it back on. Press “Enter” to input change, or disable hard drive password.

❑ Password on Boot:

It allows the user to specify whether or not a password is required to boot.

# Boot

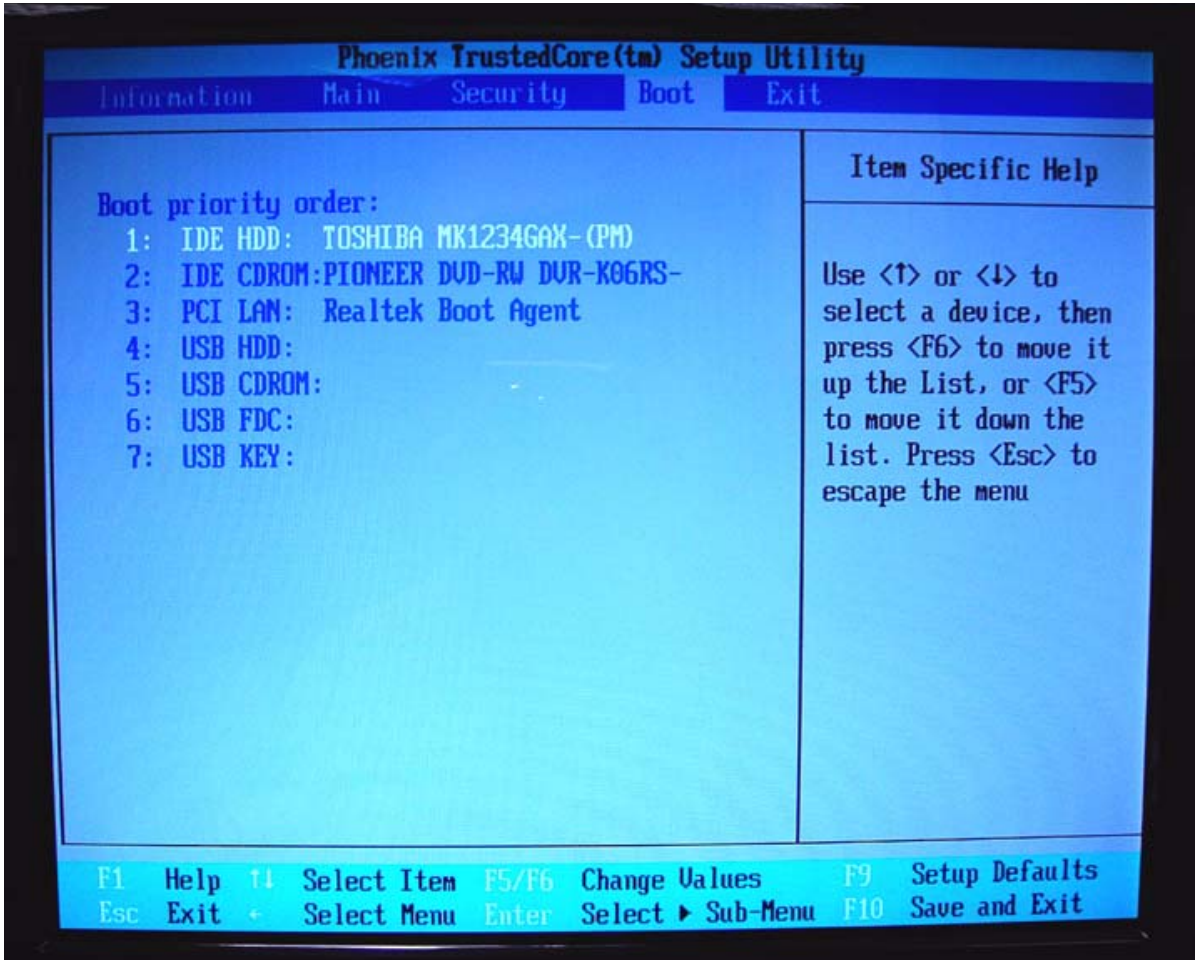

This menu allows the users to decide the order of bootable devices to load the operating system. It identifies all the bootable devices in the system and attempts to boot them in the order specified. Bootable devices include the diskette drive in module bay, the hard disk and the CD-ROM/DVD drive in module bay and onboard LAN device.

# Exit

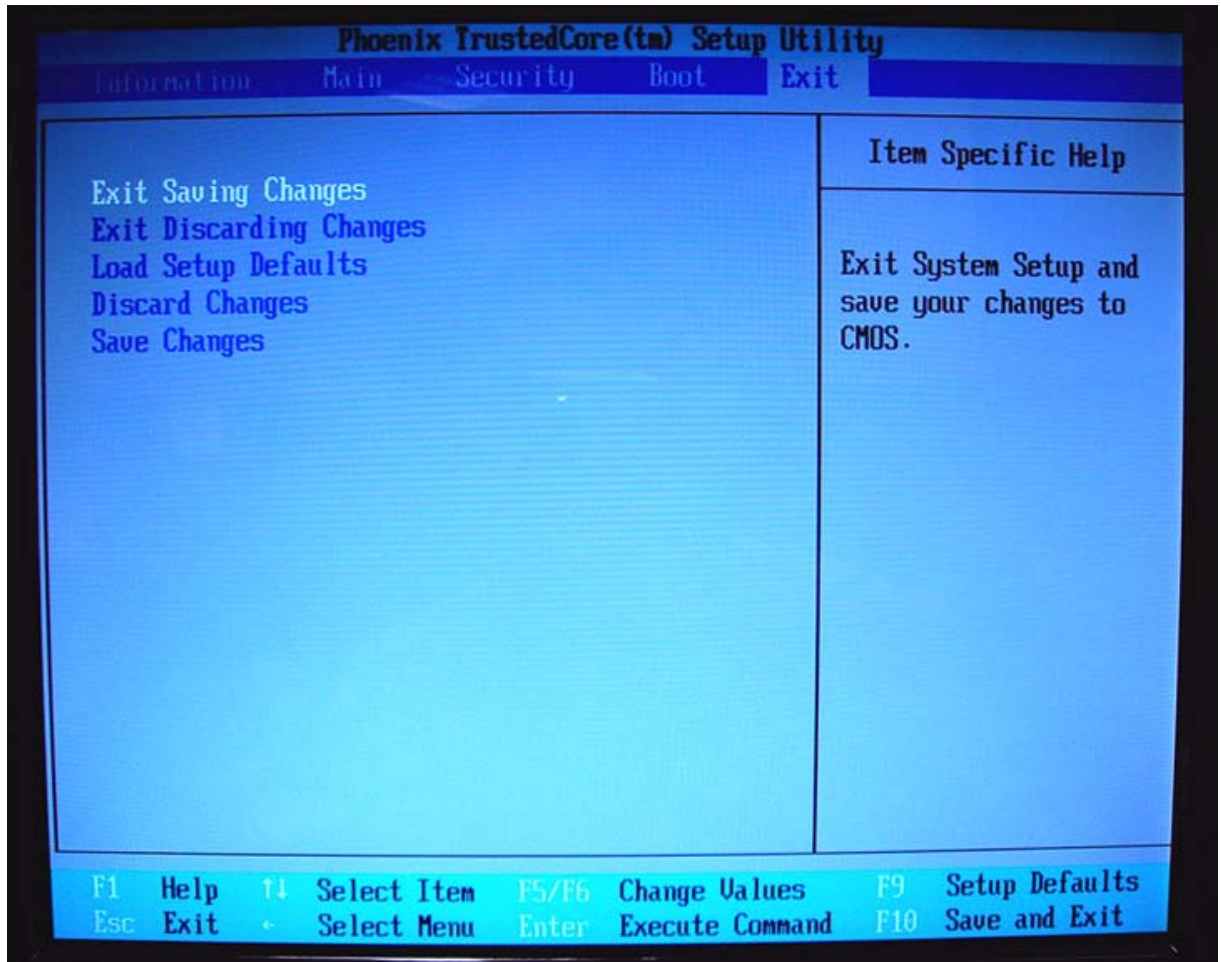

- Exit Saving Changes:  
It allows the users to save changes to CMOS and reboot the system.
- Exit Discarding Changes:  
The users can exit the Setup not to save changes.
- Load Setup Defaults:  
It allows the users to load default values in CMOS Setup.
- Discard Changes:  
The users can discard previous changes in CMOS Setup.
- Save Changes:  
The users can save current changes in CMOS Setup.



## Machine Disassembly and Replacement

---

This chapter contains step-by-step procedures on how to disassemble the notebook for maintenance and troubleshooting.

To disassemble the computer, you need the tools below:

- Wrist ground strap and conductive mat for preventing electrostatic discharge
- Small Philips screw driver
- Flat head screw driver
- Hexagonal driver
- Tweezers

**NOTE:** The screws for the different components vary in size. During the disassembly process, group the screws with the corresponding components to avoid mismatch when putting back the components. When you remove the stripe cover, please be careful not to scrape the cover.

---

# General Information

## Before You Begin

Before proceeding with the disassembly procedure, you have to make sure that:

1. The system and all peripherals are powered off.
2. The AC adaptor and all power and signal cables from the system are unplugged.
3. The battery pack is removed.

**NOTE:** There are several types of screws used to secure the main unit. The screws vary in length. Please refer to the screws table after the flowchart. Group the same type of screws together during service disassembling. Please also remember the screw location for each screw type. If you fasten the screws on the wrong location, the long screws may cause irrecoverable damage to the main board.

# Disassembly Procedure Flowchart

The flowchart gives you a graphic representation on the entire disassembly and reassembly and instructs you how to remove the components.

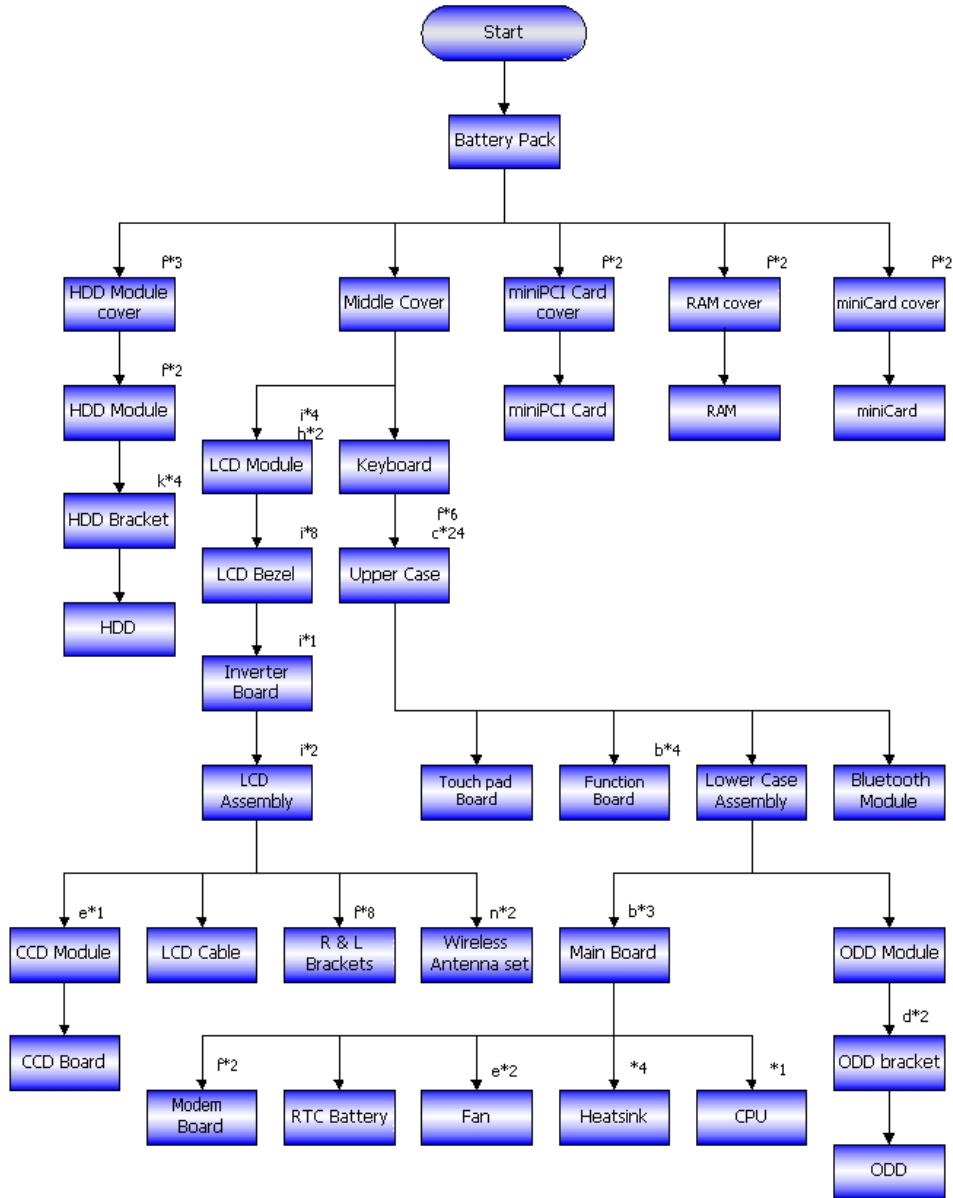

## Screws List

No.	Description	Part No.
a	SCW HEX NYL I#R-40/O#4-40 L5.5	34.00015.081
b	SCREW MACH WAFER M2*L4 NI	86.T39V1.002
c	SCRW M2.5*6 ~ L-CASE + U-CASE	86.00D28.330
d	SCRW M2*L3	86.00D29.620
e	SCRW M2.5*5 WAFER B-ZN ROHS	86.00D47.630
f	SCREW M2*L3 NYLOK CR 3+	86.00E25.723

---

Screws List

No.	Description	Part No.
g	SCREW M2*L3 NON-NYLOK CR3+	86.00E31.723
h	SCREW M2.5*L6 NYLOK CR3+	86.00E33.736
i	SCREW M2.5*L8 NYLOK CR3+	86.00E34.738
j	SCREW M2*L8 NI NON-NYLOK	86.00E35.228
k	SCREW M3x4(86.9A524.4R0)	86.9A524.4R0
l	SCRW M2*4 WAFER NI	86.9A552.4R0
m	SCREW NI M2*6L	86.9A552.6R0
n	SCRW M2.5*L3(NON NYLOK)	86.9A523.3R0

# Disassembly Procedure

## Removing the Battery Pack

1. Unlock the battery pack.
2. Slide the battery latch, hold it then remove the battery.



## Removing the HDD Module

1. Release the three screws fastening the HDD module cover.
2. Detach the HDD module cover.
3. Release the two screws holding the HDD module then pull the HDD module as arrow indicates and remove the HDD module.

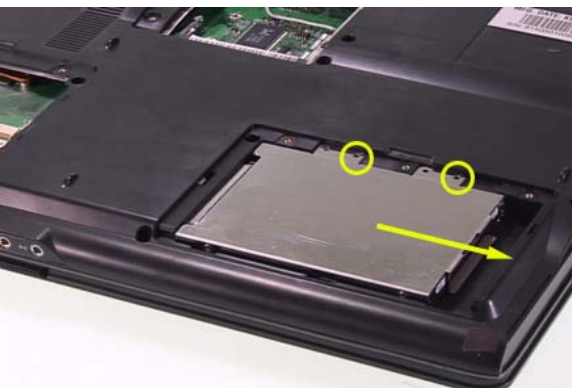

## Removing the MiniPCI Card and the Memory

1. Release the two screws securing the miniPCI cover.
2. Remove the miniPCI cover.
3. Disconnect the wireless antenna then remove the wireless LAN card.

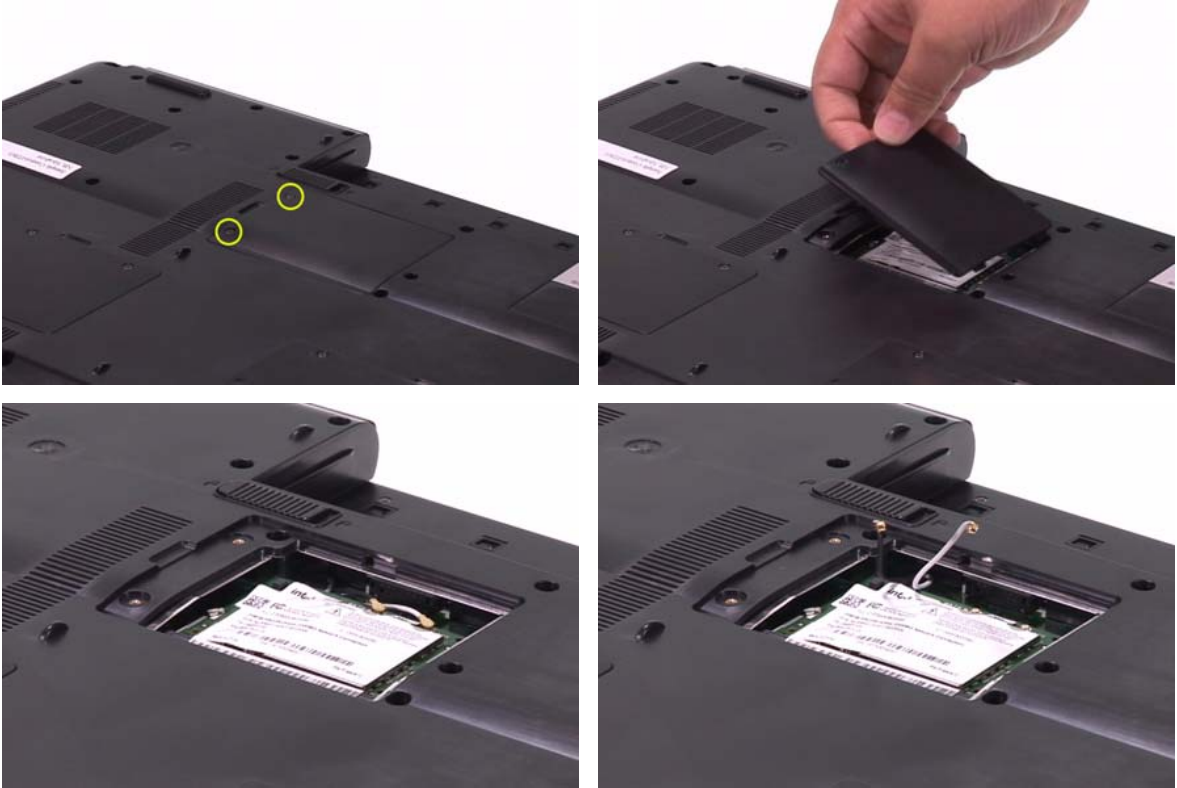

4. Release the two screws securing the RAM cover and remove the RAM cover.
5. Press the left and right latches to pop up the memory.



## Removing the Keyboard

1. Open the notebook as shown.
2. Remove the middle cover.
3. There are four latches securing the keyboard.
4. Push those latches by the screw driver as shown and the keyboard will pop up a little.
5. Remove the keyboard and reverse it.
6. Carefully pull the keyboard FFC lock, then disconnect the keyboard FFC.

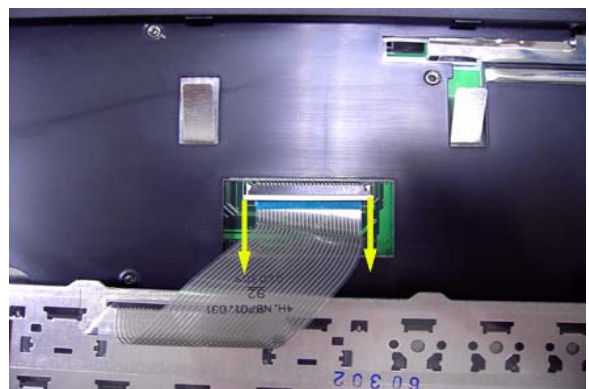

## Separating the LCD Module and Main Unit

1. Pull carefully and disconnect the LCD cable.
2. Tear off the tape securing the wireless antenna and pull out the wireless antenna.
3. Release the two screws securing the LCD hinges on the bottom side.
4. Release the two screws fastening the LCD hinges on the rear side.
5. Release the two screws holding the LCD hinges as shown.
6. Then separate the LCD module from the main unit.

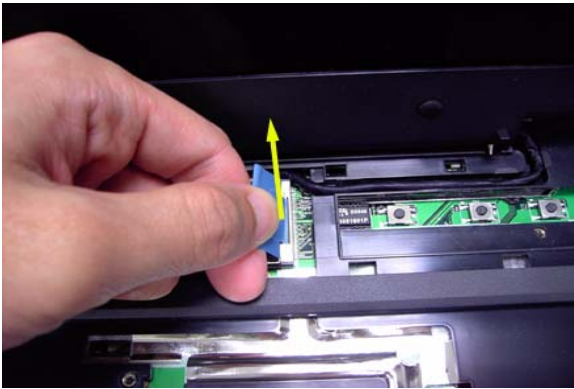



## Disassembling the Main Unit

### Separating the Upper Case and the Lower Case

1. Release the connector lock and disconnect the touch pad FFC.
2. Release the connector lock and disconnect the function keyboard FFC.
3. Release the three screws securing the upper case.
4. Release the 27 screws holding the lower case.
5. Lift the upper case carefully and disconnect the lid switch cable.
6. Then separate the upper and the lower case.

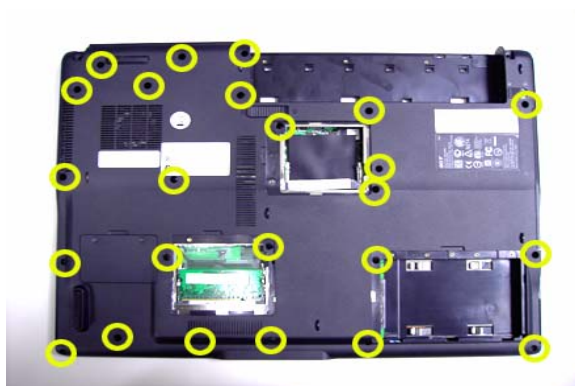
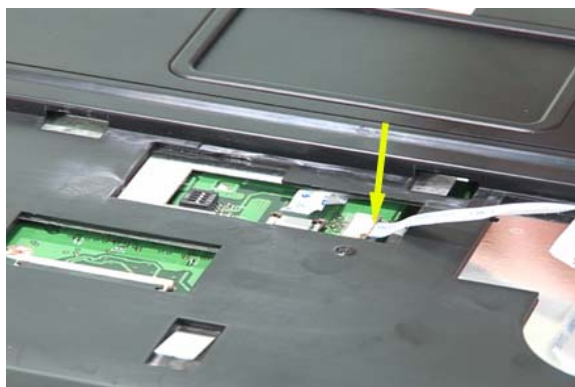
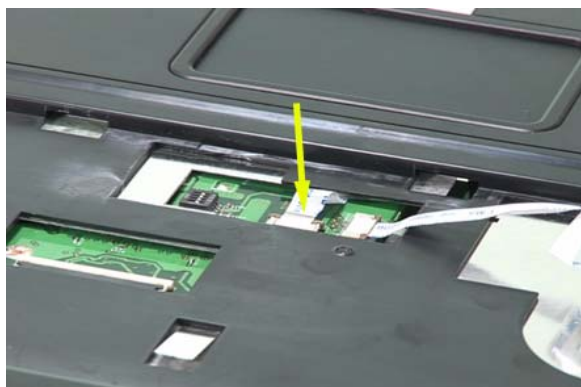



### Removing the Function Keyboard

1. Release the FFC lock and disconnect the function keyboard FFC.
2. Release the four screws holding the function keyboard bracket.
3. Then remove the function keyboard bracket.
4. Carefully disconnect the microphone cable and remove the function keyboard.

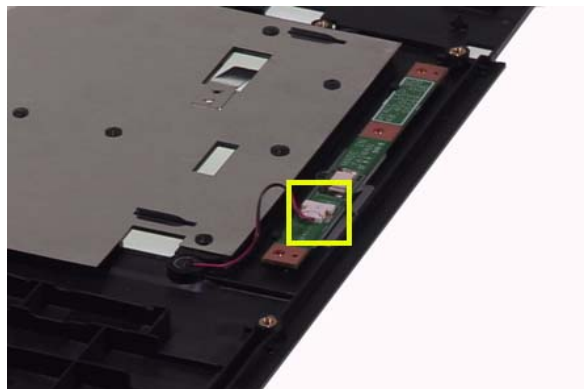
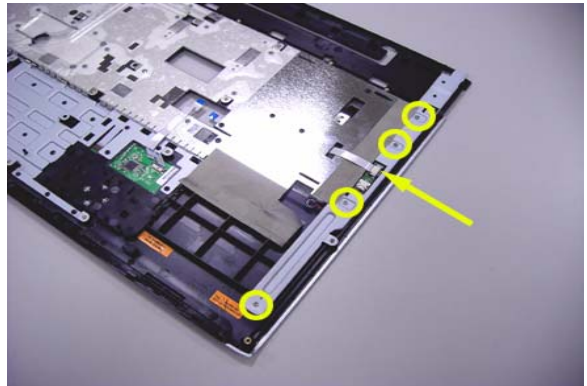
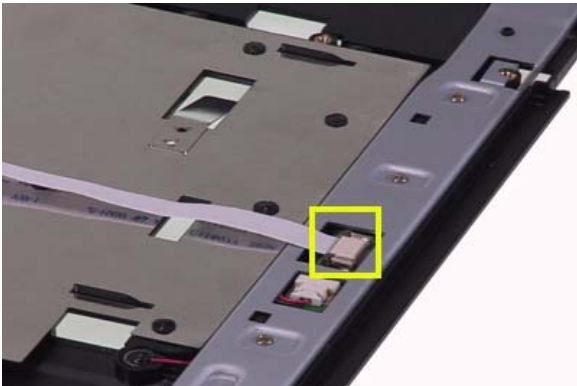

## Removing the Touch Pad Board

1. Carefully release the FFC lock and disconnect the touch pad board FFC.
2. There are 13 latches holding the touch pad bracket.
3. Unlock those latches with a screw driver as shown then detach the touch pad bracket.
4. Detach the touch pad board.

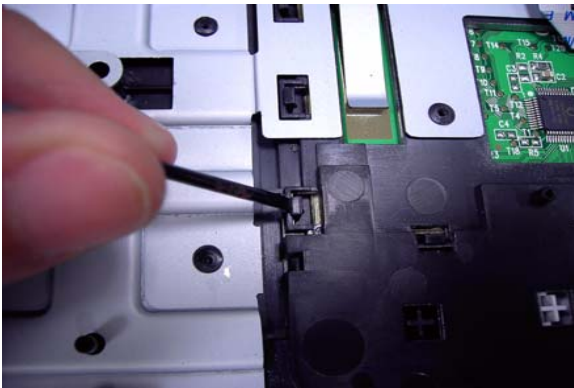
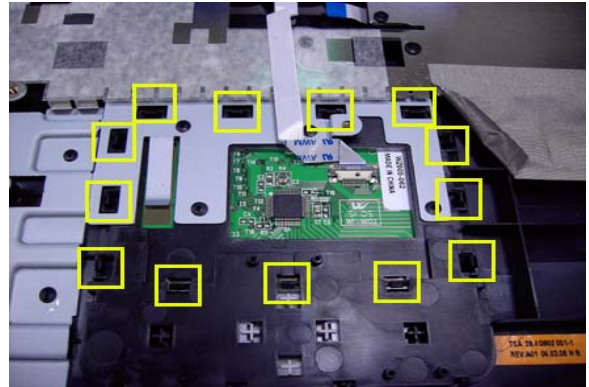
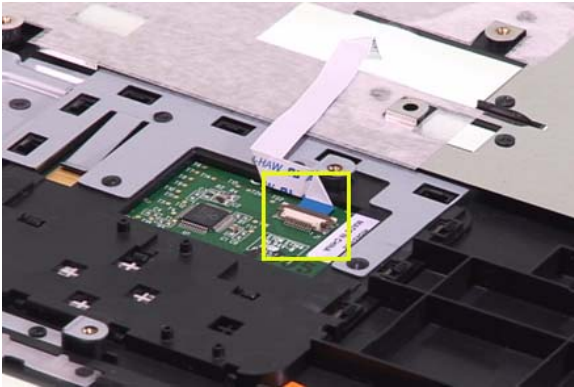

## Removing the ODD Module and Dummy Card

1. Slightly pull the ODD module and remove it.
2. Pull the dummy card from the slot and remove it.

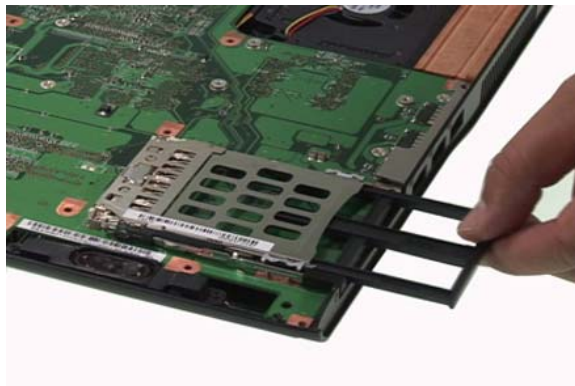

## Removing the Main Board

1. Disconnect the fan cable.
2. Disconnect the speaker cable and Bluetooth module cable.
3. Remove the four screws securing the main board.
4. Then detach the main board from the lower case.

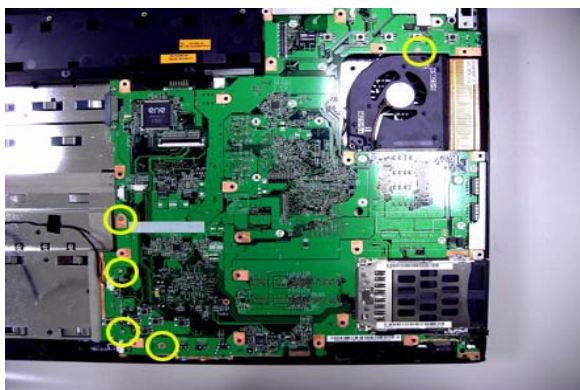
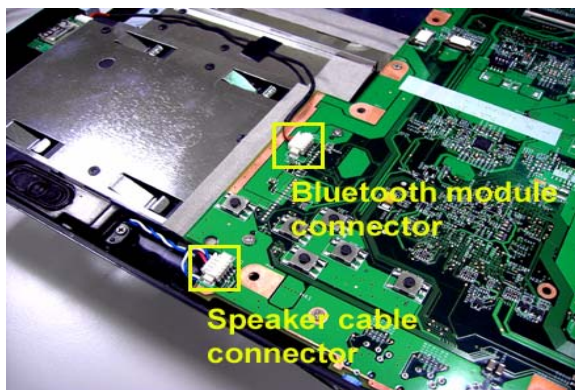
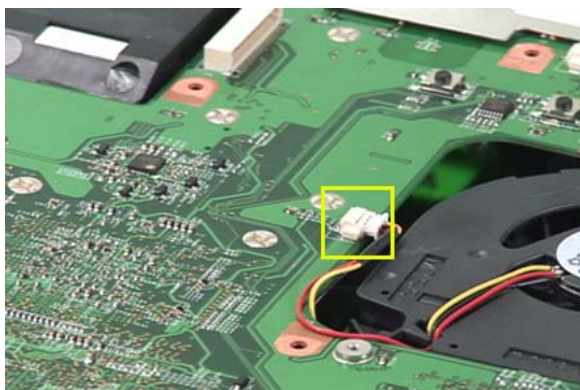

---

### Removing the System Fan

1. Release the two screws holding the heatsink.
2. Remove the heatsink.

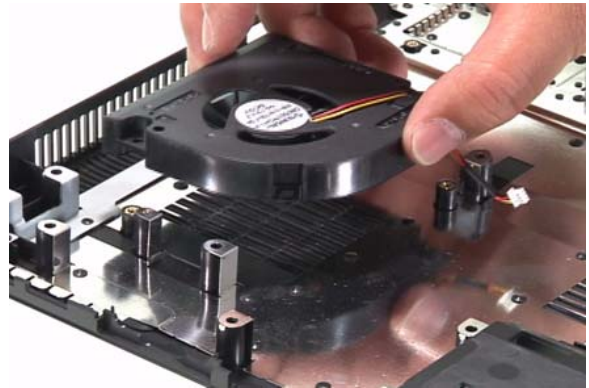
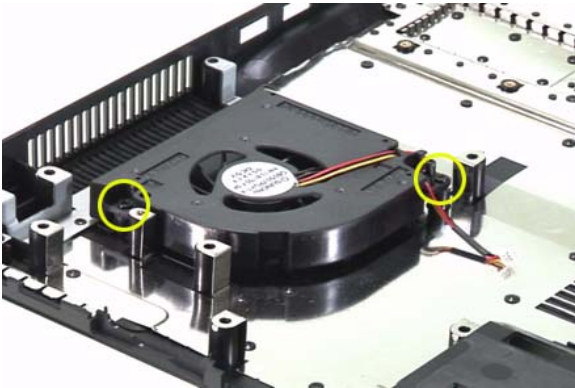

### Removing the Bluetooth Module

1. Detach the bluetooth module from the lower case.
2. Carefully disconnect the bluetooth module cable.

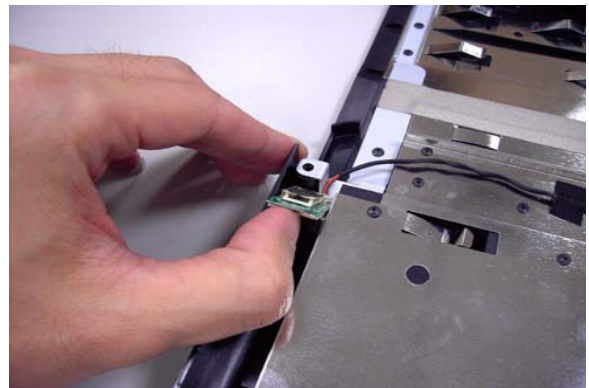
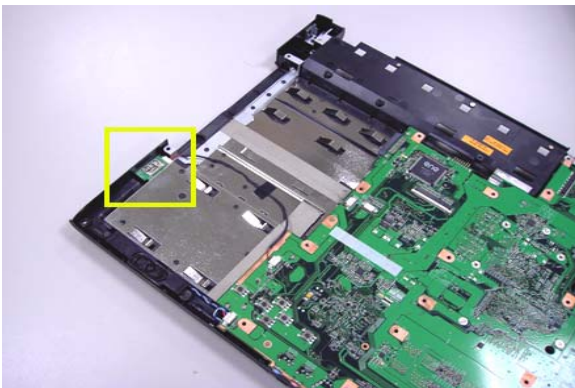

## Removing the Speakers

1. Release the four screws securing the left and right speakers.
2. Remove the speakers from the lower case.

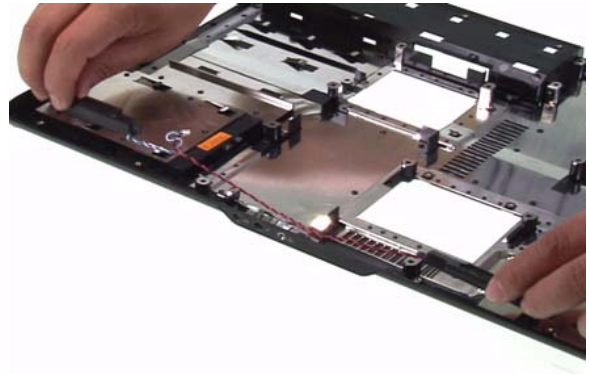
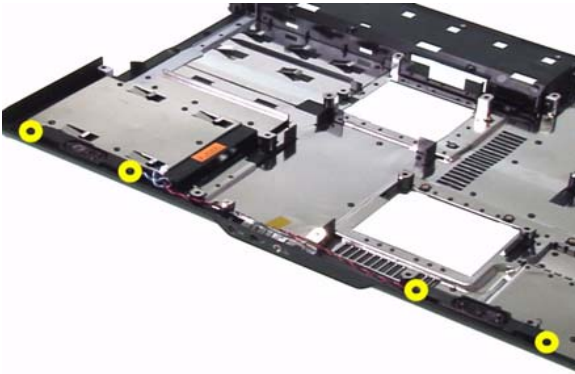

## Removing the MDC Module

1. Carefully disconnect the MDC cable.
2. Release the two screws securing the MDC board then detach the MDC board.
3. Disconnect the MDC board cable.

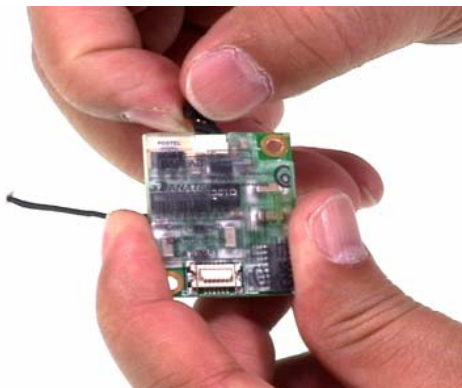
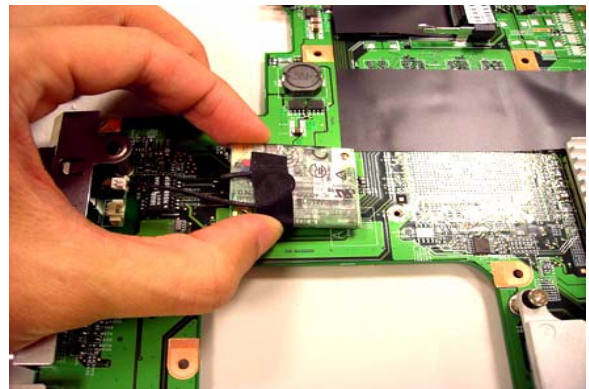
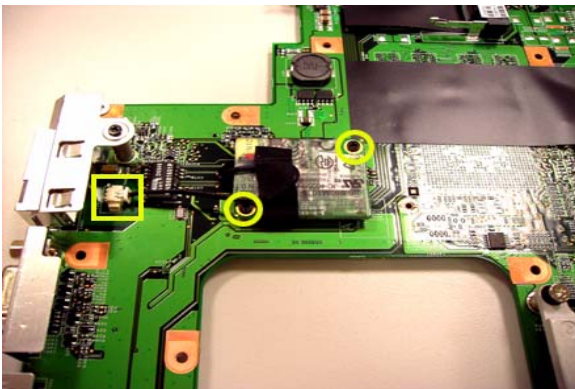

---

## Remove the Heatsink Module

1. Release the five screws securing the heatsink.
2. Remove the heatsink module.

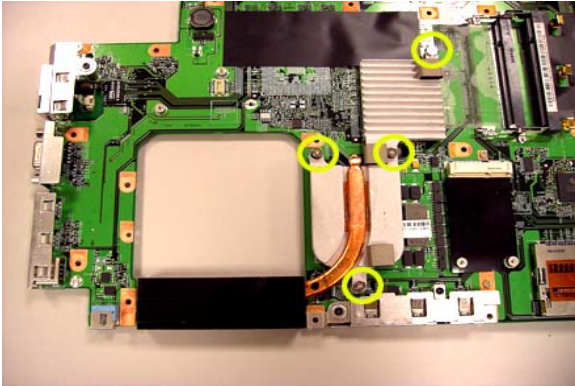

## Removing the CPU

1. Release the screw counter clockwise with a flat screw driver.
2. Detach the CPU from the CPU socket.

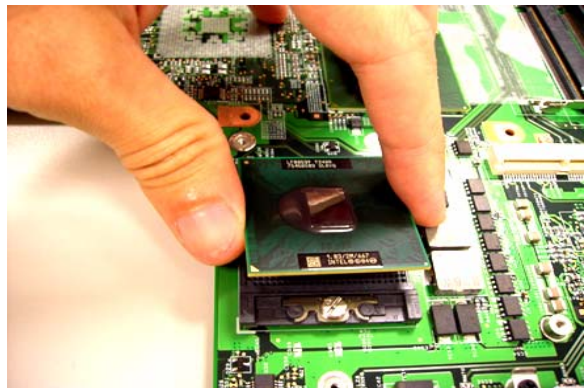
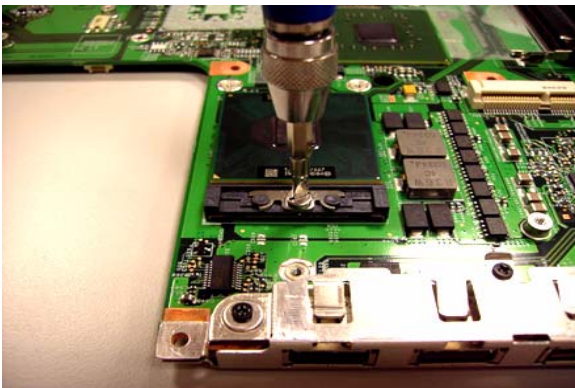

## LCD Disassembly

1. Remove the eight rubber caps on the LCD bezel and release the eight screws securing the LCD bezel.
2. Detach the LCD bezel from the LCD module as shown.
3. Release the screw holding the inverter board.
4. Disconnect the inverter board cables as shown and remove the inverter board.

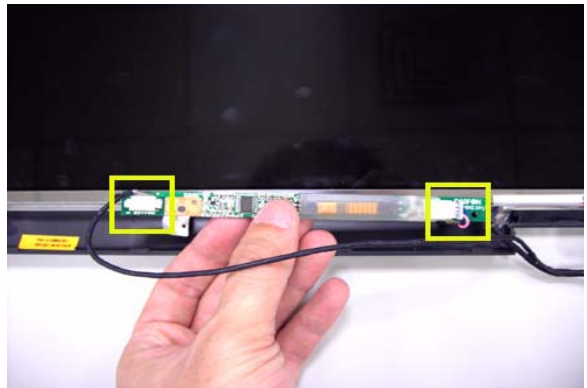



5. Release the four screws securing the LCD panel.
6. Detach the LCD panel carefully and reverse it as shown.
7. Tear off the tapes holding the LCD panel cable carefully then disconnect the LCD panel.
8. Remove the antenna from the LCD cover.

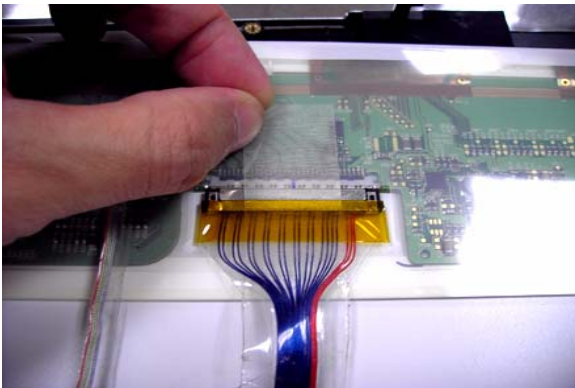

- 
9. Release the four screws securing the left LCD bracket then remove the left LCD bracket.
  10. Repeat the anterior step to remove the right LCD bracket.

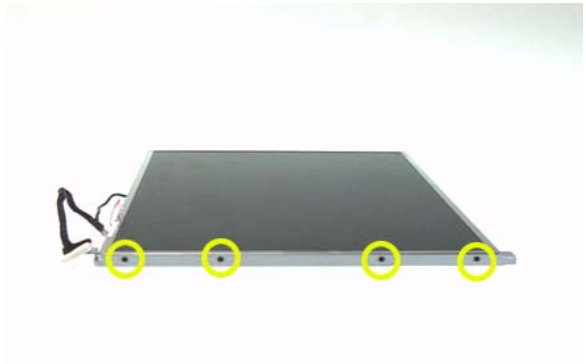
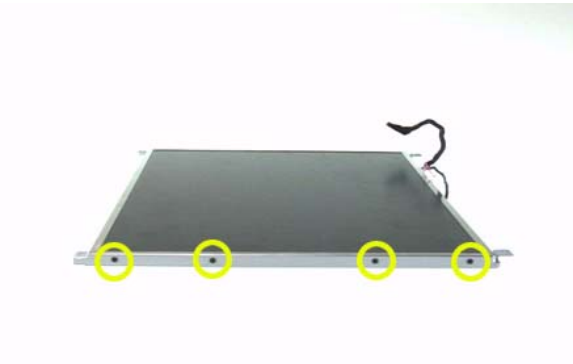

11. Release the screw holding the CCD module and carefully pull the CCD module cable and LCD cable through the latch bar and LCD cover.
12. Remove the CCD module cap.
13. Remove the CCD module ring.
14. Push the CCD module upper case a little bit.
15. Then Separate the lower case from the upper case.
16. Release the two screws holding the CCD module board the detach the CCD module board.

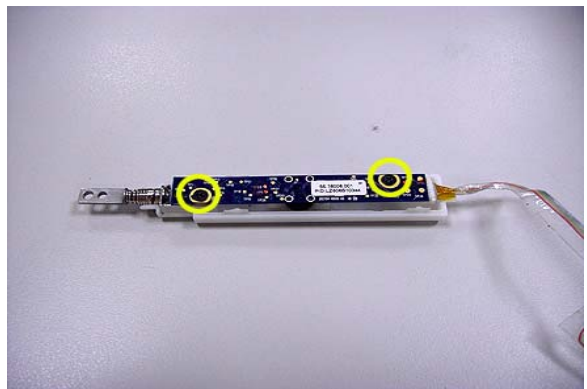
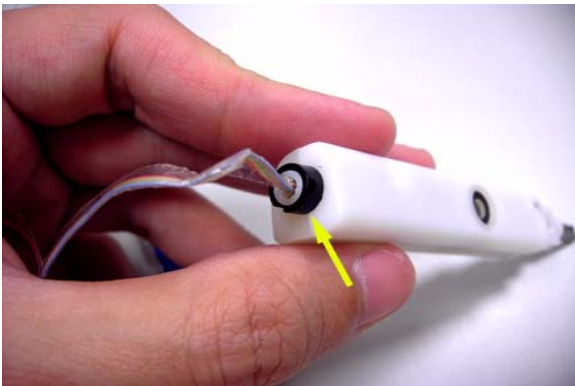
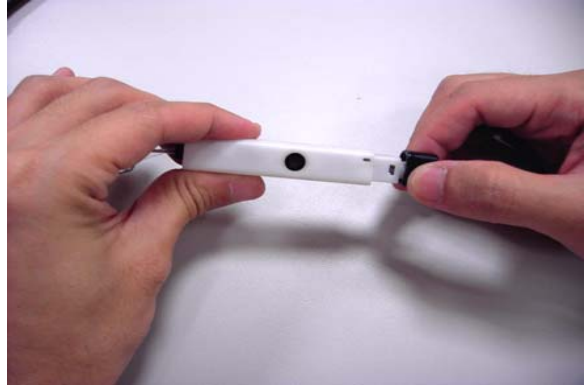

# Troubleshooting

---

Please use the following procedures as a guide for computer problems.

**NOTE:** The diagnostic tests are intended to test only Acer products. Non-Acer products, prototype cards, or modified options may occur errors or invalid responses.

1. Obtain the detailed fail symptoms as many as possible.
2. Verify the symptoms by attempting to recreate, running the diagnostic tests or repeating the same operation.
3. Disassemble and assemble the unit without any power sources.
4. If any problem occurs, you can perform visual inspection before you follow this chapter's instructions. You can check the following:
  - Power cords are properly connected and secured;
  - There are no obvious shorts or opens;
  - There are no obviously burned or heated components;
  - All components appear normal.

---

# System Check Procedures

## External Diskette Drive Check

Do the following procedures to isolate the possible effects from a controller, driver, or diskette. A writable, diagnostic diskette is required.

**NOTE:** Make sure that the diskette does not have more than one label attached. Multiple labels may cause damage to the drive or make the drive fail.

1. Boot from the diagnostic diskette and start the diagnostic programs.
2. See if FDD test is passed as the programs run the FDD test.
3. Follow the instructions in the message window.

If errors occur with the internal diskette driver, reconnect the diskette connector on the system board. If the errors still remain:

1. Reconnect the external diskette drive.
2. Replace the external diskette driver.
3. Replace the main board.

## External CD-ROM Drive Check

Do the following procedures to isolate the possible effects from a controller, driver, or CD-ROM.

**NOTE:** Make sure that the CD-ROM does not have any label attached. The label may cause damage to the drive or make the drive fail.

1. Boot from the diagnostic diskette and start the diagnostic programs.
2. See if CD-ROM test is passed when the programs run the CD-ROM test.
3. Follow the instructions in the message window.

If errors occur, reconnect the connector on the system board. If the errors still remain:

1. Reconnect the external CD-ROM drive.
2. Replace the external CD-ROM drive.
3. Replace the main board.

## Keyboard or Auxiliary Input Device Check

Remove the external keyboard if the internal keyboard is under test. If the internal keyboard does not work or an unexpected error appears, make sure that the flexible cable extending from the internal keyboard is correctly connected on the system board. If the keyboard is correctly connected, run the Keyboard test.

If errors occur, do the following procedures in sequence to correct the problems. Do not replace a non-defective FRU.

1. Reconnect the keyboard cable.
2. Replace the keyboard.
3. Replace the main board.

The following auxiliary input devices are supported by this computer.

- ❑ Numeric keypad
- ❑ External keyboard

If any of these devices do not function, reconnect the cable and repeat the anterior procedures.

## Memory Check

Follow the procedures below to correct the memory errors.

1. Boot from the diagnostic diskette and start the diagnostic programs.
2. Go to the diagnostic memory in the test items.
3. Press F2 in the test items.
4. Follow the instructions in the message window.

**NOTE:** Make sure that the DIMM is correctly inserted into the connector. A wrong connection will cause errors.

## Power System Check

To verify the symptoms, power on the computer by using the following power sources separately.

1. Remove the battery pack.
2. Connect the power adaptor and check the power supply.
3. Disconnect the power adaptor and install the battery pack, then check the power supply.

If you think there is a power supply problem, please go to “Check the Power Adaptor” and “Check the Battery Pack” in this chapter.

## Check the Power Adaptor

Unplug the power adaptor cable from the computer and measure the output voltage at the plug of the power adaptor cable. See the illustration and follow the procedures below.

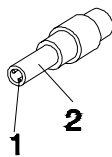

pin 1: +19V to +20.5V  
pin 2: 0V, ground

1. If the voltage is not correct, replace the power adaptor.
2. If the voltage is within the range:
  - (1) Replace the system board.
  - (2) If the problem is still not resolved, see “Undetermined Problems”.
  - (3) If the voltage is not correct, go to the next step.

**NOTE:** An audible noise from the power adaptor does not always indicate a defect.

3. If the power-on indicator does not light up, check the power cord of the power adaptor for continuity and correct installation.
4. If the operational charge does not work, see “Check the Battery Pack”.

---

## Check the Battery Pack

Follow the procedures below to check the battery pack.

From software, this helps to identify the problem is on recharging or discharging.

1. Check the Power Management in Control Panel.
2. Then confirm that the parameters shown in the screen for Current Power Source and Total Battery Power Remaining are correct.
3. Repeat the step 1 and step 2 for both battery and adaptor.

From hardware, this helps to identify whether you should replace the battery pack or not.

1. Power off the system.
2. Remove the battery pack and measure the voltage between terminals one (+) and seven (-). There are seven terminals totally. See the illustration below.

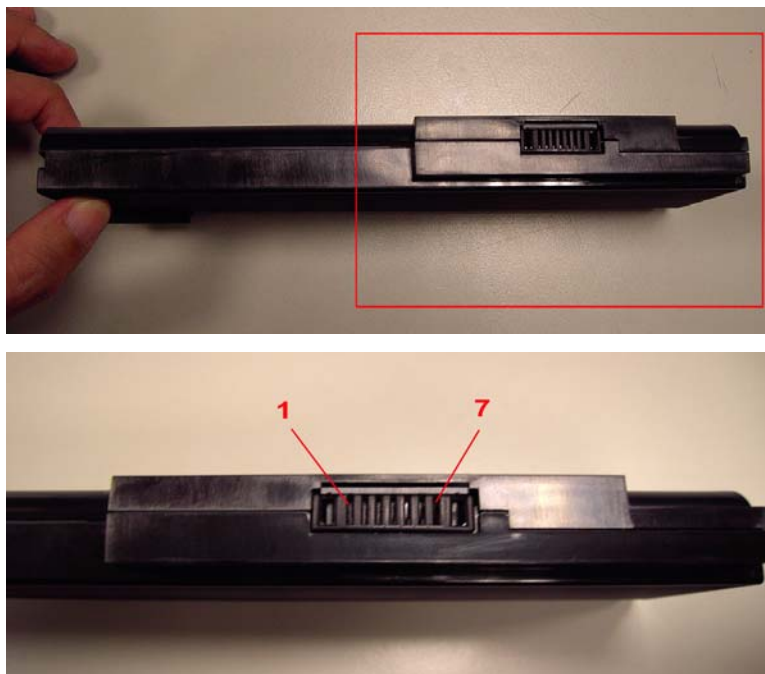

3. If the voltage is still less than 7.5V after recharging, replace the battery.

If the battery status indicator does not light up, remove the battery pack. After the battery pack returns to room temperature, reinstall it to the system.

If the charge indicator does not light up, replace the battery pack. If the charge indicator still does not light up, replace the AC/DC charger board.

## Touchpad Check

If the touchpad does not work, follow the procedures one at a time to correct the problem. Do not replace a non-defective FRU.

1. After rebooting, run Tracking Pad PS2 Mode Driver. For example, run Syn touch driver.
2. Run utility with the PS/2 mouse function and check if the mouse is working.

- 
3. If the PS/2 mouse does not work, then check if the main board to switch board FPC is connected properly.
  4. If the main board to switch board FPC is connected correctly, then check if the FFC on the touch pad PCB is connected properly.
  5. If the FFC on the touch pad PCB is connected correctly, check if LS851 JP1 Pin6 = 5V are pules. If yes, then replace switch board. If not, then go to the next step.
  6. Replace the touch pad PCB.
  7. If the touch pad still does not work, then replace the FPC on Track Pad PCB.

After you use the touchpad, the pointer drifts on the screen for a short time. This self-acting pointer movement will occur when a slight, steady pressure is applied to the touchpad pointer. This symptom is not a hardware problem. No actions are necessary to be taken if the pointer movement stops in a short period of time.



---

## Power-On Self-Test (POST) Error Message

The POST error message index lists the error message and their possible causes.

**NOTE:** Perform the FRU replacement or actions in the sequence shown in Error Message List, if the FRU replacement does not solve the problem, put the original part back in the computer. Do not replace a non-defective FRU.

The error messages are listed in the coming pages to indicate the BIOS signals on the screen and the error symptoms classified by functions. If the symptom is not included on the list, please refer to “Undetermined Problems”.

**NOTE:** Most of the error messages occur during POST. Some of them show information about a hardware device, for example, the size of memory installed. Others may indicate problems with a device, such as the way it has been configured.

**NOTE:** If the system fails after you make changes in the BIOS Setup Utility menus, please reset the computer. Enter Setup and install Setup defaults to correct the errors.

# Index of Error Messages

## Error Message List

Error Messages	FRU/Action in Sequence
Struck Key	See "Keyboard or Auxiliary Input Device Check".
System CMOS checksum bad - Default configuration used	RTC battery Run BIOS Setup Utility to reconfigure system, then reboot system.
Real time clock error	RTC battery Run BIOS Setup Utility to reconfigure system time, then reboot system. Main board
Previous boot incomplete - Default configuration used	"Load Default Settings" in BIOS Setup Utility. RTC battery Main board
Invalid System Configuration Data	"Load Default Settings" in BIOS Setup Utility. Main board
Operating system not found	Enter Setup and see if fixed disk and drive A are properly identified. Diskette drive Hard disk drive Main board
Power-on indicator turns off and LCD is blank.	Power source (battery pack and power adapter.) See "Power System Check". Ensure every connector is connected tightly and correctly. Reconnect the DIMM. Main board.
Power-on indicator turns on and LCD is blank.	Power source (battery pack and power adapter.) See "Power System Check". Reconnect the LCD connector Hard disk drive LCD cable LCD inverter LCD Main board
Power-on indicator turns on and LCD is blank. But you can see POST on an external CRT.	Reconnect the LCD connectors. LCD cable LCD inverter LCD Main board
Power-on indicator turns on and a blinking cursor shown on LCD during POST.	Ensure every connector is connected tightly and correctly. Main board

# Phoenix BIOS Beep Codes

Code	Beeps	POST Routine Description
02h		Verify Real Mode
03h		Disable Non-Maskable Interrupt (NMI)
04h		Get CPU type
06h		Initialize system hardware
07h		Disable shadow and execute code from the ROM.
08h		Initialize chipset with initial POST values
09h		Set IN POST flag
0Ah		Initialize CPU registers
0Bh		Enable CPU cache
0Ch		Initialize caches to initial POST values
0Eh		Initialize I/O component
0Fh		Initialize the local bus IDE
10h		Initialize Power Management
11h		Load alternate registers with initial POST values
12h		Restore CPU control word during warm boot
13h		Initialize PCI Bus Mastering devices
14h		Initialize keyboard controller
16h	1-2-2-3	BIOS ROM checksum
17h		Initialize cache before memory autosize
18h		8254 timer initialization
1Ah		8237 DMA controller initialization
1Ch		Reset Programmable Interrupt Controller
20h	1-3-1-1	Test DRAM refresh
22h	1-3-1-3	Test 8742 Keyboard Controller
24h		Set ES segment register to 4 GB
28h		Autosize DRAM
29h		Initialize POST Memory Manager
2Ah		Clear 215 KB base RAM
2Ch	1-3-4-1	RAM failure on address line xxxx
2Eh	1-3-4-3	RAM failure on data bits xxxx of low byte of memory bus
2Fh		Enable cache before system BIOS shadow
32h		Test CPU bus-clock frequency
33h		Initialize Phoenix Dispatch Manager
36h		Warm start shut down
38h		Shadow system BIOS ROM

Code	Beeps	POST Routine Description
3Ah		Autosize cache
3Ch		Advanced configuration of chipset registers
3Dh		Load alternate registers with CMOS values
41h		Initialize extended memory for RomPilot.
42h		Initialize interrupt vectors
45h		POST device initialization
46h	2-1-2-3	Check ROM copyright notice
47h		Initialize I20 support
48h		Check video configuration against CMOS
49h		Initialize PCI bus and devices
4Ah		Initialize all video adapters in system
4Bh		QuietBoot start (optional)
4Ch		Shadow video BIOS ROM
4Eh		Display BIOS copyright notice
50h		Display CPU type and speed
51h		Initialize EISA board
52h		Test keyboard
54h		Set key click if enabled
55h		Enable USB devices
58h	2-2-3-1	Test for unexpected interrupts
59h		Initialize POST display service
5Ah		Display prompt "Press F2 to enter SETUP"
5Bh		Disable CPU cache
5Ch		Test RAM between 512 and 640 KB
60h		Test extended memory
62h		Test extended memory address lines
64h		Jump to User Patch1
66h		Configure advanced cache registers
67h		Initialize Multi Processor APIC
68h		Enable external and CPU caches
69h		Setup System Management Mode (SMM) area
6Ah		Display external L2 cache size
6Bh		Load custom defaults (optional)
6Ch		Display shadow-area message
6Eh		Display possible high address for UMB recovery
70h		Display error messages
72h		Check for configuration errors
76h		Check for keyboard errors

Code	Beeps	POST Routine Description
7Ch		Set up hardware interrupt vectors
7Eh		Initialize coprocessor if present
80h		Disable onboard Super I/O ports and IRQs
81h		Late POST device initialization
82h		Detect and install external RS232 ports
83h		Configure non-MCD IDE controllers
84h		Detect and install external parallel ports
85h		Initialize PC-compatible PnP ISA devices
86h		Re-initialize onboard I/O ports
87h		Configure Motherboard Configurable Devices (optional)
88h		Initialize BIOS Data Area
89h		Enable Non-Maskable Interrupts (NMIs)
8Ah		Initialize Extended BIOS Data Area
8Bh		Test and initialize PS/2 mouse
8Ch		Initialize floppy controller
8Fh		Determine number of ATA drives (optional)
90h		Initialize hard-disk controllers
91h		Initialize local-bus hard-disk controllers
92h		Jump to UserPatch2
93h		Build MPTABLE for multi-processor boards
95h		Install CD ROM for boot
96h		Clear huge ES segment register
97h		Fixup Multi Processor table
98h	1-2	Search for option ROMs. One long, two short beeps on checksum failure.
99h		Check for SMART drive (optional)
9Ah		Shadow option ROMs
9Ch		Set up Power Management
9Dh		Initialize security engine (optional)
9Eh		Enable hardware interrupts
9Fh		Determine number of ATA and SCSI drives
A0h		Set time of day
A2h		Check key lock
A4h		Initialize Typematic rate
A8h		Erase F2 prompt
AAh		Scan for F2 key stroke
ACh		Enter SETUP
A Eh		Clear Boot flag
B0h		Check for errors

Code	Beeps	POST Routine Description
B1h		Inform RomPilot about the end of POST.
B2h		POST done- prepare to boot operating system
B4h	1	One short beep before boot
B5h		Terminate QuietBoot (optional)
B6h		Check password (optional)
B7h		Initialize ACPI BIOS
B9h		Prepare Boot
BAh		Initialize SMBIOS
BBh		Initialize PnP Option ROMs
BCh		Clear parity checkers
BDh		Display MultiBoot menu
BEh		Clear screen (optional)
BFh		Check virus and backup reminders
C0h		Try to boot with INT 19
C1h		Initialize POST Error Manager (PEM)
C2h		Initialize error logging
C3h		Initialize error display function
C4h		Initialize system error handler
C5h		PnPnd dual CMOS (optional)
C6h		Initialize notebook docking (optional)
C7h		Initialize notebook docking late
C8h		Force check (optional)
C9h		Extended checksum (optional)
CAh		Redirect Int 15h to enable remote keyboard
CBh		Redirect Int 13h to Memory Technologies Devices such as ROM, RAM, PCMCIA, and serial disk.
CCh		Redirect Int 10h to enable remote serial video
CDh		Re-map I/O and memory for PCMCIA
CEh		Initialize digitizer and display message.
D2h		Unknown interrupt
The following are for boot block in Flash ROM		
E0h		Initialize the chipset
E1h		Initialize the bridge
E2h		Initialize the CPU
E3h		Initialize the system timer
E4h		Initialize system I/O
E5h		Check force recovery boot
E6h		Checksum BIOS ROM
E7h		Go to BIOS
E8h		Set Huge Segment

Code	Beeps	POST Routine Description
E9h		Initialize Multi Processor
EAh		Initialize OEM special code
EBh		Initialize PIC and DMA
ECh		Initialize Memory type
EDh		Initialize Memory size
EEh		Shadow Boot Block
EFh		System memory test
F0h		Initialize interrupt vectors
F1h		Initialize Run Time Clock
F2h		Initialize video
F3h		Initialize System Management Mode
F4h	1	Output one beep
F5h		Clear Huge Segment
F6h		Boot to Mini DOS
F7h		Boot to Full DOS

# Index of Symptom-to-FRU Error Message

## LCD-Related Symptoms

Symptom/Error	Action in Sequence
LCD backlight doesn't work. LCD is too dark. LCD brightness cannot be adjusted. LCD contrast cannot be adjusted.	Enter BIOS Utility to execute "Load Setup Default Settings", then reboot system. Reconnect the LCD connectors. Keyboard (if contrast and brightness function key do not work). LCD inverter ID LCD cable LCD inverter LCD System board
Unreadable LCD screen Missing pels in characters Abnormal screen Wrong color displayed	Reconnect the LCD connector. LCD inverter ID LCD cable LCD inverter LCD System board
LCD has extra horizontal or vertical lines displayed.	LCD inverter ID LCD inverter LCD cable LCD System board

## Indicator-Related Symptoms

Symptom/Error	Action in Sequence
Indicator incorrectly remains off or on, but system runs correctly.	Reconnect the inverter board Inverter board System board

## Power-Related Symptoms

Symptom/Error	Action in Sequence
Power shuts down during operation.	Power source (battery pack and power adapter). See "Power System Check". Battery pack Power adapter Hard drive & battery connection board System board
The system doesn't power on.	Power source (battery pack and power adapter). See "Power System Check". Battery pack Power adapter Hard drive & battery connection board System board



## Power-Related Symptoms

Symptom/Error	Action in Sequence
The system doesn't power-off.	Power source (battery pack and power adapter). See Power System Check". Hold and press the power switch for more than 4 seconds. System board
Battery can't be charged.	See "Check the Battery Pack". Battery pack System board

## PCMCIA-Related Symptoms

Symptom/Error	Action in Sequence
System cannot detect the PC Card (PCMCIA).	PCMCIA slot assembly System board
PCMCIA slot pin is damaged.	PCMCIA slot assembly

## Memory-Related Symptoms

Symptom / Error	Action in Sequence
Memory count (size) appears different from actual size.	Enter BIOS Setup Utility to execute "Load Default Settings, then reboot system. DIMM System board

## Speaker-Related Symptoms

Symptom/Error	Action in Sequence
In Windows, multimedia programs, no sound comes from the computer.	Audio driver Speaker System board
Internal speakers make noise or emit no sound.	Speaker System board

## Power Management-Related Symptoms

Symptom/Error	Action in Sequence
The system will not enter hibernation.	Keyboard (if control is from the keyboard) Hard disk drive System board
The system does not enter hibernation mode and four short beeps every minute.	Press Fn + F4 and see if the computer enters hibernation mode. Touchpad Keyboard Hard disk connection board Hard disk drive System board

## Power Management-Related Symptoms

Symptom/Error	Action in Sequence
The system does not enter standby mode after closing the LCD.	LCD cover switch System board
The system does not resume from hibernation mode.	Hard disk connection board Hard disk drive System board
The system does not resume from standby mode after opening the LCD.	LCD cover switch System board
Battery fuel gauge in Windows does not go higher than 90%.	Remove battery pack and let it cool for two hours. Refresh battery (continue to use battery until power off, then charge battery). Battery pack System board
System hangs intermittently.	Reconnect hard disk/CD-ROM drives. Hard disk connection board System board

## Peripheral-Related Symptoms

Symptom/Error	Action in Sequence
System configuration does not match the installed devices.	Enter BIOS Setup Utility to execute "Load Default Settings", then reboot system. Reconnect hard disk/CD-ROM/diskette drives.
External display does not work correctly.	Press Fn + F5, LCD/CRT/Both display switching System board
USB does not work correctly.	System board
Print problems	Ensure the "Parallel Port" in the "Onboard Devices Configuration" of BIOS Setup Utility is set to Enabled. Onboard Devices Configuration Run printer self-test. Printer driver Printer cable Printer System Board
Serial or parallel port device problems.	Ensure the "Serial Port" in the Devices Configuration" of BIOS Setup Utility is set to Enabled. Device driver Device cable Device System board

## Keyboard/Touchpad-Related Symptoms

Symptom/Error	Action in Sequence
Keyboard (one or more keys) does not work.	Reconnect the keyboard cable. Keyboard System board

---

### Keyboard/Touchpad-Related Symptoms

Symptom/Error	Action in Sequence
Touchpad does not work.	Reconnect touchpad cable. Touchpad board System board

### Modem-Related Symptoms

Symptom/Error	Action in Sequence
Internal modem does not work correctly.	Modem phone port modem combo board System board

**NOTE:** If you can not correct the problems according to the anterior tables, see “Undetermined Problems”.

---

## Intermittent Problems

Intermittent system hang problems can be caused by a variety of reasons that have nothing to do with a hardware defect, such as cosmic radiation, electrostatic discharge, or software errors. FRU replacement should be considered only when a recurring problem exists.

When analyzing an intermittent problems, follow the procedures below:

1. Run the advanced diagnostic test for the system board in loop mode at least 10 times.
2. If no error is detected, do not replace any FRU.
3. If any error is detected, replace the FRU. Rerun the test to verify that there are no more errors.

---

## Undetermined Problems

The diagnostic problems does not identify which devices fail, which devices are incorrectly installed, whether a short circuit happens, or whether the system is inoperative.

**NOTE:** Verify if all devices attached are supported by the computer.

**NOTE:** Verify if the power supply used at the time of failure is operating correctly. You can refer to “Power System Check”.

Follow the procedures below to isolate the failing FRU. Do not isolate non-defective FRU.

1. Power off the computer.
2. Visually check the devices. If any problems are found, replace the FRU.
3. Remove or disconnect all of the following devices:
  - Non-Acer devices
  - Printer, mouse, and other external devices
  - Battery Pack
  - Hard disk drive
  - DIMM
  - CD-ROM / Diskette drive module
  - PC cards
4. Power on the computer.
5. Determine if the problem has been resolved.
6. If the problem does not recur, reconnect the removed devices one at a time until you find the failed FRU.
7. If the problem remains, replace the following FRU one at a time. Do not replace a non-defective FRU.
  - System board
  - LCD assembly

## Jumper and Connector Location

### Top View

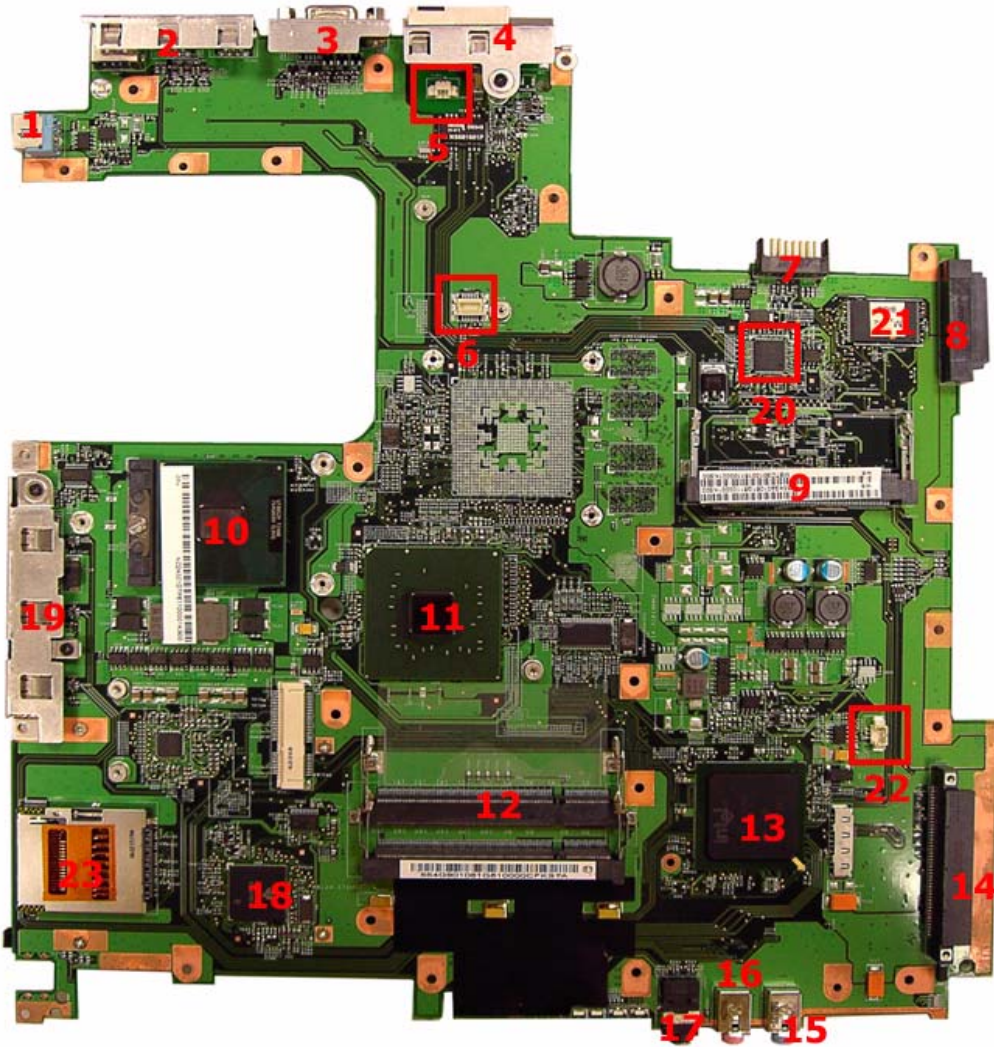

No.	Description	No.	Description
1	DC-in jack	2	USB connector
3	CRT connector	4	RJ11 & RJ45 connector
5	MDC module connector	6	MDC board connector
7	Main battery connector	8	ODD connector
9	Mini PCI slot	10	CPU
11	North bridge	12	DIMM slot
13	South bridge	14	HDD connector

---

No.	Description	No.	Description
15	Line-in jack	16	Microphone-in jack
17	Line-out jack	18	Cardbus controller
19	USB connector	20	LAN controller
21	BIOS ROM	22	RTC battery connector
23	5-in-1 card reader		

# Bottom View

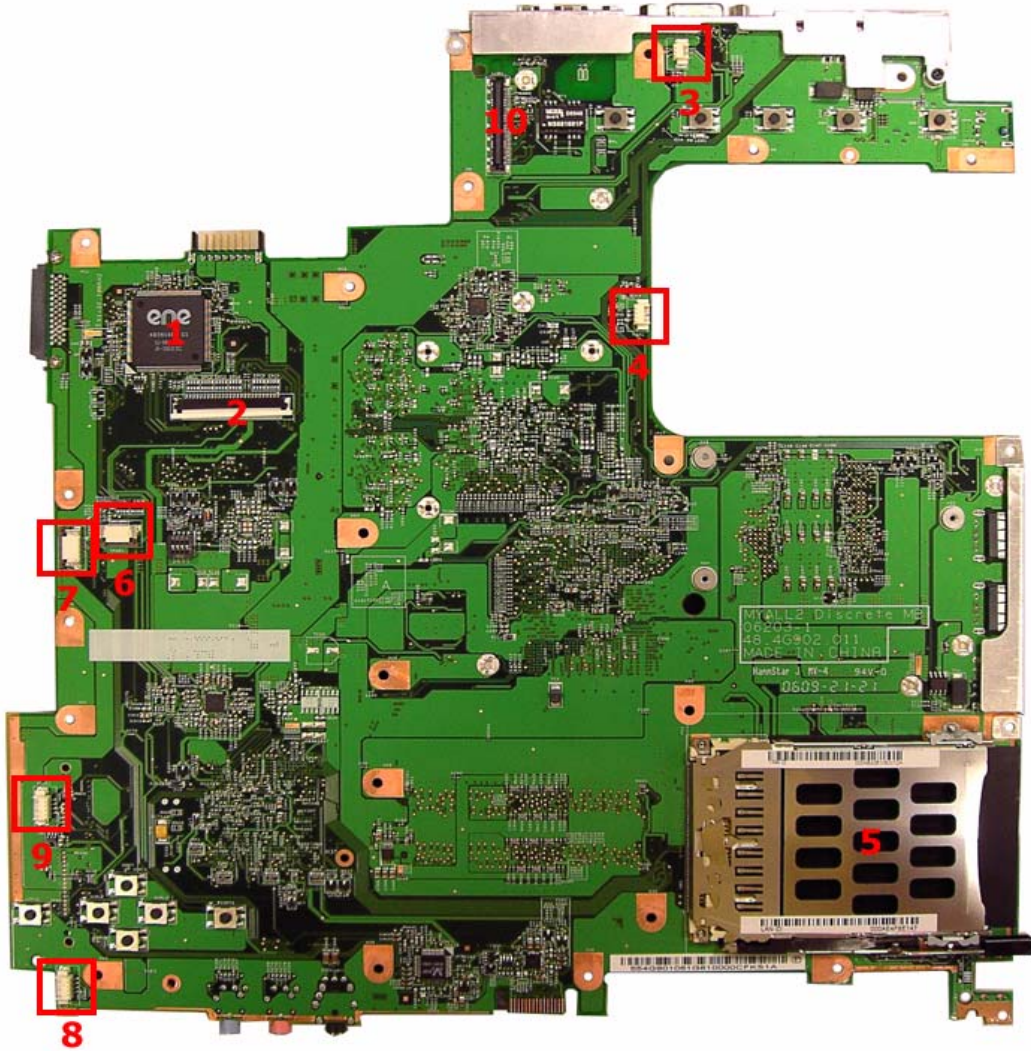

Item	Description	Item	Description
1	Keyboard controller	2	Keyboard connector
3	Lid switch connector	4	System fan connector
5	PCMCIA card reader	6	Function key board connector
7	Touch pad board connector	8	Speaker connector
9	Bluetooth module connector	10	LCD cable connector



## FRU (Field Replaceable Unit) List

---

This chapter offers the FRU (Field Replaceable Unit) list in global configuration of Aspire 9410 / 7110 and TravelMate 5610 / 5110. Refer to this chapter whenever ordering the parts to repair or for RMA (Return Merchandise Authorization).

Please note that when ordering FRU parts, you should check the most up-to-date information available on your regional web or channel. For whatever reasons a part number is changed, it will NOT be noted on the printed service guide. For Acer authorized service providers, your Acer office may have a different part number code from those given in the FRU list of this printed service guide. You MUST use the local FRU list provided by your regional Acer office to order FRU parts for service.

**NOTE:** To scrap or to return the defective parts, you should follow the local government ordinance or regulations on how to dispose them properly, or follow the rules set by your regional Acer office on how to return it.

# Exploded Diagram



NO	PART NO	DESCRIPTION	Q'TY	REV	REMARK
1	604001001	ASSY LCD 17.1 PANEL LCD TH	00		
2	604001001	ASSY LCD bezel 17.1 bezel	00		
3	2340032001	part-L CD Mylot-2	00		
4	2340032001	part-R CD Mylot-2	00		
5	604003001	ASSY camera LOCK bezel	00		
6	361000001	ROT LCD PCB	00		
7	374000001	Lower hinge bezel	00		
8	374000001	CAS CAMERA U-CASE RING/01	00		
9	LC60000001	U-case sup. 3K1 L Mylot	00		
10	2340032001	17.1 LCD module	00		
11	2340032001	Launch board module	00		
12	1710000000	Inverter Board	00		
13	604001001	ASSY Module Cover-Texture Mylot	00		
14	9200702001	KB Durfon NSK	00		
15	604001001	ASSY U-Case--TH Side Mylot	00		
16	462000001	17.1 Frame TH Mylot	00		
17	561700001	Touch Pad CHGT AS10	00		
18	554001001	Rot Board Module Jip Storage Mylot	00		
19	604001001	Rot Board Module Jip Storage Mylot	00		
20	810000005	Battery	00		
21	604001001	ASSY DUT bezel case Mylot	00		
22	604001001	DUT MODULE	00		
23	604001001	ASSY ROT Cover_0NSP Mylot	00		
24	6040027001	ASSY ROT Dress55 Mylot	00		
25	604001001	ROT MODULE	00		
26	604001001	ASSY L-Case Side Mylot	00		
27	604001001	ASSY Interact_Cover Mylot	00		
28	604001001	ASSY DIME cover Mylot	00		
29	604003001	ASSY MIC/0001 Cover Mylot	00		
30	2210120001	FAN MODULE	00		

NO	REV	DATE	DESCRIPTION
1			
2			
3			
4			
5			
6			
7			
8			
9			
10			
11			
12			
13			
14			
15			
16			
17			
18			
19			
20			
21			
22			
23			
24			
25			
26			
27			
28			
29			
30			

# Parts

## Aspire 9410 UMA

CATEGORY	PART NAME	DESCRIPTION	ACER PART NO.
<b>ADAPTER</b>			
N/A	ADAPTER 90W LITEON PA-1900-04WR	ADT 90W LITEON PA-1900-04WR	AP.09003.005
	ADAPTER 90W DELTA ADP-90SB BBAAF	ADT 90W DELTA ADP-90SB BBAAF	AP.09001.004
<b>BATTERY</b>			
N/A	RTC BATTERY	BTY RTC MITSUBISHI ROHS	23.TCBV1.003
	BATTERY PACK LI+ 8CELL 2.4MAH SANYO	BTY PACK LI+ 8C 2.4AH SANYO	BT.00803.018
	BATTERY PACK LI+ 8CELL 2.4MAH SONY	BTY PACK LI+ 8C 2.4AH SONY	BT.00807.010
	BATTERY PACK LI+ 6CELL 2.0MAH SONY	BTY PACK LI+ 6C 2.0AH SONY	BT.00604.010
	BATTERY PACK LI-MN 6CELL 2.0MAH SANYO	BTY PACK LI-MN 6C 2.0AH SANYO	BT.00603.021
	BATTERY PACK LI-MN 6CELL 2.0MAH PANASONIC	BTY PACK LI-MN 6C 2.0AH PANA	BT.00605.005
	BLUETOOTH MODULE FOXCONN BCM2045 V01	BT MODULE FOXCONN BCM2045 V01	54.TB2V1.001
<b>BOARD</b>			
	TOUCHPAD BOARD SYNPATICTM61PUF1G372	TOUCHPAD SYNPATICTM61PUF1 G372	56.A46V1.001
	LED BOARD	MYALL LED BOARD 05569-2 (DIP)	55.TCBV1.001
	"INVERTER BOARD 17"" FOXCONN T62I240.00 ROHS"	INVERTER 17" VK.21189.402	19.TCBV1.001
	"INVERTER BOARD 17"" YEC YNV-W02"	"INVERTER 17"" YEC YNV-W02"	19.TB2V1.001
	"INVERTER BOARD 17"" O2 V189-601"	"INVERTER 17"" O2 V189-601"	19.ADFV1.001

CATEGORY	PART NAME	DESCRIPTION	ACER PART NO.
	WIRELESS LAN BOARD 802.11ABG INTEL 3945 RW	WLAN 802.11ABG INTEL 3945 RW	KI.GLN01.003
	WIRELESS LAN BOARD 802.11ABG INTEL 3945 MW2	WLAN 802.11ABG INTEL 3945 MW2	KI.GLN01.002
	WIRELESS LAN BOARD 802.11ABG INTEL 3945 MW1	WLAN 802.11ABG INTEL 3945 MW1	KI.GLN01.001
	WIRELESS LAN BOARD 802.11BG FOXCONN BCM4318 MURA	WLAN 802.11BG FOX BCM4318 MURA	54.A74V1.002
	MODEM BOARD FOXCONN T60M893.03	MODEM MDC1.5 FOXCONNT60M893.0 3	54.TCBV1.001
N/A	TV TUNER BOARD	TV TUNER MINIPCI M103 HYBRID	54.ADFV1.001
	TV TUNER BOARD	TV TUNER MINIPCI M104 H/W ENCO	54.ADFV1.002
<b>CABLE</b>			
N/A	BLUETOOTH CABLE	B/T CABLE HT MYALL	50.TCBV1.001
	TOUCHPAD CABLE	T/P FFC CABLE MYALL	50.TCBV1.002
	LAUNCH BOARD CABLE	LAUNCH BOARD FFC CABLE MYALL	50.TCBV1.003
N/A	COVER SWITCH CABLE	COVER SWITCH HT MYALL	50.TCBV1.004
N/A	"LCD CABLE 17.1"" WXGA"	"LCD CABLE 17.1"" WXGA HT MYALL "	50.TCBV1.005
N/A	"LCD CABLE 17.1"" WXGA"	"C.A. 17.1"" WXGA HT MYALL-2 "	50.ADFV1.001
N/A	MODEM CABLE	MDC CABLE HT MYALL	50.TCBV1.006



CATEGORY	PART NAME	DESCRIPTION	ACER PART NO.
N/A	POWER CORD 10A 250V 3PIN ITALY	CORD 10A 250V 3P ITALY BK	27.01518.711?
	POWER CORD 10A 250V 3PIN ITALY	CORD ITALY 10A 250V 3P BK	27.01518.611
	POWER CORD 10A 250V SWISS	CODE 10A 250V 3P SWISS BK	27.01518.691
	POWER CORD 10A 250V SWISS	CODE SWISS POWER 10A 250V BK	27.01518.581
	POWER CORD 10A 250V 3PIN BK SOUTH AFRICA	CODE 16A 250V SOUTH AFRICA BK	27.01518.681
	POWER CORD 10A 250V 3PIN BK SOUTH AFRICA	CODE SOUTH AFRICA 10A 250V BK	27.01518.571
	POWER CORD 7A 250V 2PIN KOREAN	CODE 7A250V 2P 1830 KOREAN	27.01518.531
	POWER CORD 7A 125V 2PIN JAPEN	CODE JAPAN 7A 125V 2P BK	27.01518.551
	POWER CORD 2.5A 250V AUSTRALIA	CODE 2.5A 250V AUSTRALIA BK	27.01518.621
	POWER CORD 10A 125V 3PIN US BK	CODE 10A 125V 3P US BK	27.01518.641
	POWER CORD 10A 125V US	CODE US 10A 125V BK	27.T30V1.001
	POWER CORD 10A 250V 3PIN CHINA BK	CORD 10A 250V 3P CHINA BK	27.01518.701
	POWER CORD 10A 250V 3PIN CHINA	CORD CHINA 10A 250V 3P	27.01518.591
	POWER CORD 10A 250V SOUTH AFRICA BK	CORD 10A 250V SOUTH AFRICA BK	27.01518.721
	POWER CORD 2.5A 250V SOUTH AFRICA BK	CORD 2.5A 250V SOUTH AFRICA BK	27.01518.631
	POWER CABLE 16A 250V 3PIN EUR BK	CORD 16A 250V 3P EUR BK	27.01518.731
	POWER CORD 220V 3PIN EUR	CORD EUR 220V 3P BK	27.T30V1.004
	POWER CORD 2.5A 125V USA	CORD USA/W CNS 2.5A 125V 8121-	27.01518.781
	POWER CORD 5A 250V 3PIN UK BK	CODE 5A 250V 3P UK BK	27.03118.001
	POWER CORD 3A 250V 3PIN UK	CODE UK 3A 250V 3P BK	27.01518.541
	POWER CORD ACA / ACNZ	POWER CODE ACA / ACNZ ANNIE	27.03218.021
	POWER CODE 7A 125V 2PIN JAPAN	CODE 7A 125V JAPAN 2PIN BK	27.03518.161
	POWER CODE 10A 250V 3PIN DENMARK BK	CODE 10A 250V 3P DENMARK BK	27.01518.671
	POWER CORD 10A 3PIN BK	CODE DENMARK 10A 3P BK	27.01518.561
<b>CASE / COVER / BRACKET ASSEMBLY</b>			

CATEGORY	PART NAME	DESCRIPTION	ACER PART NO.
	MIDDLE COVER	ASSY MIDDLE COVER--AS MYALL	60.ACKV1.003
	MINI PCI COVER	ASSY MINIPCI COVER MYALL	42.TCBV1.003
N/A	MINI CARD COVER	ASSY MINICARD COVER MYALL	42.TCBV1.004
	HDD COVER	ASSY HDD COVER MYALL	42.ACKV1.001
	DIMM COVER	ASSY DIMM COVER MYALL	42.TCBV1.002
	LED BOARD SUPPORT BRACKET	U-CASE SUP. BKT L MYALL	33.TCBV1.001
	OPTICAL BRACKET	ODDBRKT MYALL	33.TCBV1.002
	UPPER CASE W/COVER SWITCH CABLE	ASSY U_CASE--AS SLIDE MYALL2	60.ADFV1.002
	LOWER CASE W/SPEAKER	ASSY L-CASE W/O CARD READER	60.ADFV1.001
	COMBO BEZEL	ASSY COMBO ODD BEZEL GB	42.TCBV1.011

CATEGORY	PART NAME	DESCRIPTION	ACER PART NO.
N/A	DVD DUAL BEZEL	ASSY DVD_DUAL ODD BEZEL	42.TCBV1.012
	DVD SUPER MULIA BEZEL	ASSY S_MULTI ODD BEZEL GBASE	42.TCBV1.013
	DVD SUPER MULIA BEZEL	ASSY ODD SLOT-IN BEZEL	42.TCBV1.014
	HDD CHASSIS	ASSY HDD CHASSIS MYALL	33.TCBV1.003
	"LCD PANEL 17.1"" W/LOGO"	"ASSY LCD 17.1"" PANEL-AS MYALL "	60.ACKV1.005
	"LCD BEZEL 17.1"" W/LOGO"	"ASSY LCD BEZEL 17.1"" MYALL "	60.TCBV1.004
	HINGE PACK LEFT/RIGHT	"HINGE PACK 17"" LEFT/RIGHT"	6K.TCBV1.001
	LCD BARCKET LEFT	"BRKT LCD 17.1"" L MYALL "	33.TCBV1.005
	LCD BRACKET RIGHT	"BRKT LCD 17.1"" R MYALL "	33.TCBV1.004
N/A	CAMERA HOLDER	HLDR CAMERA SIDE RIM KIRKINI	42.ADFV1.001
N/A	CAMERA LOWER CASE CAS	CAS CAMERA L-CASE KIRKINI	39.ADFV1.001
N/A	CAMERA HOLDER CAP	HLDR CAMERA CAP KIRKINI	42.ADFV1.002
N/A	CAMERA LATCH	LATCH CAMERA HINGH KIRKINI	33.ADFV1.003
N/A	CAMERA LOWER CASE	ASSY CAMERA LCASE KIRKINI	60.ADFV1.006
<b>SPEAKER</b>			
N/A	SPEAKER LEFT/RIGHT	SPEAKERMYALL	23.TCBV1.001
<b>COMBO MODULE</b>			

CATEGORY	PART NAME	DESCRIPTION	ACER PART NO.
	COMBO MODULE 24X	ASSY ODD COMBO MYALL2	6M.ADFV1.001
	CDRW/DVD COMBO DRIVE 24X PHILIPS SCB5265 W/O BEZEL	COMBO PHI/SCB5265 MYALL NOBZL	KO.02408.010
	CDRW/DVD COMBO DRIVE 24X LITEON SOSC-2485K W/O BEZEL	COMBO LIT/SOSC-2485K NO BZL	KO.02409.022
<b>DVD-RW DRIVE</b>			
N/A	DVD-RW DRIVE 8X DUAL	ASSY ODD DUAL MYALL2	6M.ADFV1.002
	DVD-RW DRIVE 8X DUAL TS-L532U W/O BEZEL	DUAL TOS/TS-L532U W/BOLSENA BZ	KU.00801.005
	DVD-RW DRIVE 8X DUAL PHILIPS SDVD8441 W/O BEZEL	DUAL PHI/SDVD8441 NO BZL MORAR	KU.00809.002
	DVD-RW DRIVE 8X SUPER MULTI SLOT IN	ASSY ODD S-MULTI MYALL2	6M.ADFV1.003
	DVD-RW DRIVE 8X SUPER MULTI SLOT IN TOSHIBA TS-L632D W/O BEZEL	S-MULT 8X TST/TS-L632D W/O BZL	KU.00801.014
	DVD-RW DRIVE 8X SUPER MULTI SLOT IN LITEON SSM-8515S W/O BEZEL	S-MULTI LTN/SSM-8515S BOLSEN-E	KU.00804.022
	DVD-RW DRIVE 8X SUPER MULTI SLOT IN PHI SDVD-8821 W/O BEZEL	SUP-MULT PHI/SDVD-8821 KERKINI	KU.00809.005
	DVD-RW DRIVE 8X SUPER MULTI SLOT IN LITEON SSM-8515S W/O BEZEL	S-MULTI LTN/SSM-8515S MYALL/2	KU.00804.037
	DVD-RW DRIVE 8X SUPER MULTI SLOT IN	ASSY ODD SLOT-IN PIONEER	6M.ADFV1.004
	DVD-RW DRIVE 8X SUPER MULTI SLOT IN PIONEER DVR-K06RS W/O BEZEL	SUP-MULT PIO/DVR-K06RS SLOT LF	KU.00805.027
	DVD-RW DRIVE 8X SUPER MULTI SLOT IN	ASSY ODD SLOT-IN PANASONIC	6M.ADFV1.005
	DVD-RW DRIVE 8X SUPER MULTI SLOT IN PANASONIC UJ-855 W/O BEZEL	SUP-MULT PAN/UJ-845 SLOT LF AG	KU.00807.029
<b>CPU</b>			

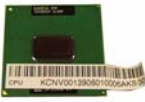

CATEGORY	PART NAME	DESCRIPTION	ACER PART NO.
	CPU DC YONAH T2300 1.66GMHZ INTEL	IC CPU DC YONAH T2300 1.66G PGA	KC.23001.DTP
	CPU DC YONAH T2600 2.17GMHZ INTEL	IC CPU DC YONAH T2600 2.17G PGA	KC.26001.DTP
	CPU DC YONAH T2500 2GMHZ INTEL	IC CPU DC YONAH T2500 2G PGA	KC.25001.DTP
	CPU DC YONAH T2400 1.83GMHZ INTEL	IC CPU DC YONAH T2400 1.83G PGA	KC.24001.DTP
	CPU DC YONAH T2300 1.66GMHZ INTEL	IC CPU DC YONAH T2300 1.66 PGA	KC.23E01.DTP
	CPU YONAH CEL-M 430 1.73GNHZ INTEL	IC CPU YONAH CEL- M 430 1.73 PGA	KC.N0001.430
	CPU YONAH CEL-M 420 1.6GMHZ INTEL	IC CPU YONAH CEL- M 420 1.6 PGA	KC.N0001.420
<b>FAN</b>			
	FAN	FANSUNONMYALL	23.TCBV1.004
	FAN	FAN FORCECON MYALL	23.TCBV1.004
	FAN	FAN KME MYALL	23.TCBV1.004
<b>HDD</b>			

CATEGORY	PART NAME	DESCRIPTION	ACER PART NO.
N/A	HDD 60G 4200RPM SEAGATE ST960812A	HDD 60GB SEAGATE ST960812A	KH.06001.006
	HDD 60G HITACHI HTS421260H9AT00	HDD 60GB HGST HTS421260H9AT00	KH.06007.009
	HDD 60G 4200RPM TOSHIBA MK6025GAS	HDD 60GB TOSHIBA MK6025GAS	KH.06004.004
	HDD 60G 5400RPM SEAGATE ST96812A	HDD 60GB SEAGATE ST96812A	KH.06001.007
	HDD 60G 5400RPM TOSHIBA	HDD 60GB TOSHIBA 5400RPM	KH.06004.007
	HDD 60G 5400RPM HITACHI HTS541260H9AT00	HDD 60GB HGST HTS541260H9AT00	KH.06007.011
	HDD 80G 4200RPM SEAGATE ST980829A	HDD 80GB SEAGATE ST980829A	KH.08001.021
	HDD 80G 4200RPM HITACHI HTS421280H9AT00	HDD 80GB HGST HTS421280H9AT00	KH.08007.011
	HDD 80G 4200RPM TOSHIBA MK8025GAS	HDD 80GB TOSHIBA MK8025GAS	KH.08004.003
	HDD 80G 5400RPM SEAGATE ST98823A	HDD 80GB SEAGATE ST98823A	KH.08001.022
	HDD 80G 5400RPM WD WD800UE-22HCT0	HDD 80GB WD WD800UE-22HCT0	KH.08008.027
	HDD 80G 5400RPM TOSHIBA	HDD 80GB TOSHIBA 5400RPM	KH.08004.006
	HDD 80G 5400RPM HITACHI	"HDD 80G 2.5" 5400RPM HGST"	KH.08007.013
	HDD 100G 4200RPM SEAGATE ST9100825A	HDD 100GB SEAGATE ST9100825A	KH.10001.006
	HDD 100G HITACHI HTS421210H9AT00	HDD 100GB HGST HTS421210H9AT00	KH.10007.002
	HDD 100G TOSHIBA MK1031GAS	HDD 100GB TOSHIBA MK1031GAS	KH.10004.001
	HDD 100G 5400RPM HITACHI 13G1591 ROHS	HDD 100GB HGST 13G1591 ROHS	KH.10007.004
	HDD 100G 5400RPM SEAGATE ST9100824A	HDD 100GB SEAGATE ST9100824A	KH.10001.007
	HDD 100G 5400RPM TOSHIBA MK1032GAX	HDD 100GB TOSHIBA MK1032GAX	KH.10004.002
	HDD 100G 5400RPM SAMSUNG HM100JC	HDD 100GB SAMSUNG HM100JC	KH.1000B.002
	HDD 120G HITACHI HTS421212H9AT00	HDD 120GB HGST HTS421212H9AT00	KH.12007.008
	HDD 120G 4300RPM SEAGATE ST9120824A	HDD 120GB SEAGATE ST9120824A	KH.12001.023
	HDD 120G 4200RPM SEAGATE MK1233GAS	HDD 120G MK1233GAS 4200RPM ROH	KH.12004.001

CATEGORY	PART NAME	DESCRIPTION	ACER PART NO.
N/A	HDD 120G 4200RPM HITACHI 0A26308	HDD 120GB HGST 0A26308 ROHS	KH.12007.006
	HDD 120G 5400RPM SEAGATE ST9120821A	HDD 120GB SEAGATE ST9120821A	KH.12001.024
	HDD 120G 5400RPM TOSHIBA	HDD 120GB TOSHIBA 5400RPM	KH.12004.002
	HDD 160G 5400RPM SEAGATE ST9160821A	HDD 160GB SEAGATE ST9160821A	KH.12001.024
<b>HEATSINK</b>			
	CPU HEATSINK	ASSY CPU HSINK CCI UMA MYALL	34.TBHV1.001
<b>KEYBOARD</b>			
	AS9400/7100 KEYBOARD DARFON US INTERNATIONAL	AS9400/7100 KEYBOARD DARFON US INTERNATIONAL	KB.ACF07.001
	AS9400/7100 KEYBOARD DARFON CHINESE	AS9400/7100 KEYBOARD DARFON CHINESE	KB.ACF07.002
	AS9400/7100 KEYBOARD DARFON SPANISH	AS9400/7100 KEYBOARD DARFON SPANISH	KB.ACF07.003
	AS9400/7100 KEYBOARD DARFON THAI	AS9400/7100 KEYBOARD DARFON THAI	KB.ACF07.004
	AS9400/7100 KEYBOARD DARFON BRAZILIAN PROTUGESE	AS9400/7100 KEYBOARD DARFON BRAZILIAN PROTUGESE	KB.ACF07.005
	AS9400/7100 KEYBOARD DARFON KOREA	AS9400/7100 KEYBOARD DARFON KOREA	KB.ACF07.006
	AS9400/7100 KEYBOARD DARFON UK	AS9400/7100 KEYBOARD DARFON UK	KB.ACF07.007
	AS9400/7100 KEYBOARD DARFON GERMAN	AS9400/7100 KEYBOARD DARFON GERMAN	KB.ACF07.008
	AS9400/7100 KEYBOARD DARFON ITALIAN	AS9400/7100 KEYBOARD DARFON ITALIAN	KB.ACF07.009
	AS9400/7100 KEYBOARD DARFON FRENCH	AS9400/7100 KEYBOARD DARFON FRENCH	KB.ACF07.010

CATEGORY	PART NAME	DESCRIPTION	ACER PART NO.
	AS9400/7100 KEYBOARD DARFON SWISS/G	AS9400/7100 KEYBOARD DARFON SWISS/G	KB.ACF07.011
	AS9400/7100 KEYBOARD DARFON PORTUGUESE	AS9400/7100 KEYBOARD DARFON PORTUGUESE	KB.ACF07.012
	AS9400/7100 KEYBOARD DARFON ARABIC	AS9400/7100 KEYBOARD DARFON ARABIC	KB.ACF07.013
	AS9400/7100 KEYBOARD DARFON BELGIUM	AS9400/7100 KEYBOARD DARFON BELGIUM	KB.ACF07.014
	AS9400/7100 KEYBOARD DARFON SWEDEN	AS9400/7100 KEYBOARD DARFON SWEDEN	KB.ACF07.015
	AS9400/7100 KEYBOARD DARFON CZECH	AS9400/7100 KEYBOARD DARFON CZECH	KB.ACF07.016
	AS9400/7100 KEYBOARD DARFON HUNGAIAN	AS9400/7100 KEYBOARD DARFON HUNGAIAN	KB.ACF07.017
	AS9400/7100 KEYBOARD DARFON NORWAY	AS9400/7100 KEYBOARD DARFON NORWAY	KB.ACF07.018
	AS9400/7100 KEYBOARD DARFON DANISH	AS9400/7100 KEYBOARD DARFON DANISH	KB.ACF07.019
	AS9400/7100 KEYBOARD DARFON TURKISH	AS9400/7100 KEYBOARD DARFON TURKISH	KB.ACF07.020
	AS9400/7100 KEYBOARD DARFON CANADIAN FRENCH	AS9400/7100 KEYBOARD DARFON CANADIAN FRENCH	KB.ACF07.022
	AS9400/7100 KEYBOARD DARFON GREEK	AS9400/7100 KEYBOARD DARFON GREEK	KB.ACF07.024
	AS9400/7100 KEYBOARD DARFON HEBREW	AS9400/7100 KEYBOARD DARFON HEBREW	KB.ACF07.025
	AS9400/7100 KEYBOARD DARFON RUSSIAN	AS9400/7100 KEYBOARD DARFON RUSSIAN	KB.ACF07.026
	AS9400/7100 KEYBOARD DARFON SLOVENIA (SLO)	AS9400/7100 KEYBOARD DARFON SLOVENIA (SLO)	KB.ACF07.027
<b>COMMUNICATION MODULE</b>			
N/A	WIRELESS ANTENNA	ANTENNA CABLE MYALL2	25.ADFV1.001
<b>LCD</b>			
N/A	"ASSY LCD MODULE 17"" WXGA GLARE"	"ASSY 17"" LCD GLARE AS "	6M.ADFV1.011

CATEGORY	PART NAME	DESCRIPTION	ACER PART NO.
N/A	"LCD 17"" WXGA+ LG LP171WP4-TL02 GLARE"	"LCD 17""W LP171WP4-TL02 GLARE"	LK.17008.015
N/A	"LCD 17.1"" WXGA+ QDI QD17TL02-05NONE GLARE "	"LCD 17""W QDI QD17TL02-05"	LK.17109.001
N/A	"LCD 17""WXGA+ QDI QD17TL02-06 GLARE"	"LCD 17"" QD17TL02-06 GLARE"	LK.17109.002
N/A	"LCD 17.1"" WXGA+ SAMSUNG LTN170WX-L05 NONE GLARE "	"LCD 17""W LTN170WX-L05 "	LK.17106.001
N/A	"LCD 17"" WXGA+ SAMSUNG LTN170WX-L05-H GLARE"	"LCD 17""W LTN170WX-L05-H GLARE"	LK.17106.002
N/A	"LCD 17"" WXGA+ AU B170PW03 V4 GLARE "	"LCD 17""WXGA B170PW03 V4 GLARE "	LK.17105.005
N/A	"LCD 17.1"" WXGA+ AU B170PW03V3NONE GLARE "	"LCD 17""W AU B170PW03 V3"	LK.17105.006
N/A	"ASSY LCD MODULE 17"" WXGA GLARE CCD 1.3M"	"ASSY 17"" LCD GLARE CCD AS "	6M.ADFV1.012
N/A	ASSY LCD MODULE 17" WXGA GLARE CCD 300K	ASSY 17" 300K CCD GLARE AS	6M.ADFV1.013
<b>CAMERA</b>			
N/A	CAMERA CMOS 1.3M LOGITECH 961458-2000 L	CAMERA CMOS 1.3M 961458-2000 L	56.ABAV1.001
N/A	CAMERA CMOS 300K VFA BN2QA350K8SD79	CAMERA CMOS VFA BN2QA350K8SD79	56.ADFV1.001
<b>MAINBOARD</b>			
	MAINBOARD MYALL 2 W/ MODEM & MODEM CABLE & RTC BATTERY W/O CPU & MEMORY ( <b>Aspire 9410 UMA, TravleMate 5610 UMA</b> )	MYALL2 MB 06203-1 945GM (D) ( <b>Aspire 9410 UMA, TravelMate 5610 UMA</b> )	MB.TCS01.001
	MAINBOARD MYALL 2 W/ MODEM & MODEM CABLE & RTC BATTERY W/O CPU & MEMORY ( <b>Aspire 9410 DISCRETE</b> )	MYALL2 MB 06203-1 64MB VRAM (D) ( <b>Aspire 9410 DISCRETE</b> )	MB.TCT01.001
	MAINBOARD MYALL 2 W/ MODEM & MODEM CABLE & RTC BATTERY W/O CPU & MEMORY ( <b>Aspire 9410 DISCRETE, TravelMate 5610 DISCRETE</b> )	MYALL2 MB 06203-1 128MB VRAM (D) ( <b>Aspire 9410 DISCRETE, TravelMate 5610 DISCRETE</b> )	MB.TCU01.001
	MAINBOARD MYALL 2 W/ MODEM & MODEM CABLE & RTC BATTERY W/O CPU & MEMORY ( <b>Aspire 7110 UMA</b> )	MYALL2 MB 06203-1 940GML (D) ( <b>Aspire 7110 UMA</b> )	MB.TCW01.001
<b>SLOT</b>			

CATEGORY	PART NAME	DESCRIPTION	ACER PART NO.
N/A	PCMCIA SLOT 4PIN	CONN CARDBUS 4P 59330-00L0C	22.T28V1.001
<b>MEMORY</b>			
	SDIMM 256M SAMSUNG 470T3354CZ3-CD5	SODIMM 256M M470T3354CZ3-CD5	KN.2560B.017
	SDIMM 256M MICRON MT4HTF3264HY-53EB4	SODIMM 256M MT4HTF3264HY- 53EB4	KN.25604.030
	SDIMM 256M HYNIX HYMP532S64BP6-C4	SODIMM 256M HYMP532S64BP6-C4	KN.2560G.012
	DIMM 256M NANYA NT256T64UH4A1FN-37B	DIMM 256M NT256T64UH4A1FN- 37B	KN.25603.029
	SDIMM 256M INFINEON HYS64T32000HDL-3.7-A	SODIMM256MHYS64 T32000HDL-3.7-A	KN.25602.023
	SDIMM 512M NANYA NT512T64UH8A1FN-37B	SODIMM512M NT512T64UH8A1FN- 37B	KN.51203.023
	SDIMM 512M SAMSUNG M470T6554CZ3-CD5	SODIMM 512M M470T6554CZ3-CD5	KN.5120B.015
	SDIMM 512M INFINEON MHYS64T64020HDL-3.7-A	SODIMM512MHYS64 T64020HDL-3.7-A	KN.51202.021
	SDIMM 512M ELPIDA GU33512AGEPN612C	SODIMM 512M GU33512AGEPN612C	KN.51209.005
	SDIMM 512M HYNIX HYMP564S64BP6-C4	SODIMM 512M HYMP564S64BP6-C4	KN.5120G.013
	SDIMM 1G HYS64T128021HDL-3.7-A	SODIMM1G HYS64T128021HDL- 3.7-A	KN.1GB02.023
	SDIMM 1GB 533 NANYA	SO-DIMM DDRII 533 1GB NANYA	KN.1GB03.006
	SDIMM 1G GU331G0AGEPN6E2C	SODIMM 1G GU331G0AGEPN6E2 C	KN.1GB09.004
<b>MICROPHONE</b>			
MICROPHONE	MICROPHONE	MICROPHONE SUNMOWNGMYALL	23.TCBV1.002
<b>MISCELLANEOUS</b>			
MISCELLANEOUS	LCD SCREW RUBBER	RUB LCD RUBBER CUSHION BOLSENA	47.A46V1.002
MISCELLANEOUS	LCD SCREW RUBBER	RUBBER SCREW MYALL	47.TCBV1.001
MISCELLANEOUS	LOGO PLATE FOR PANEL	PLT LOGOPANEL	31.T49V1.001
MISCELLANEOUS	LOGO PLATE FOR BEZEL	"PLT BEZEL PLATE ""ACER "" LOGO "	31.A46V1.001
<b>SCREW</b>			
N/A	SCREW	SCW HEX NYL I#R- 40/O#4-40 L5.5	34.00015.081

CATEGORY	PART NAME	DESCRIPTION	ACER PART NO.
N/A	SCREW	SCREW MACH WAFER M2*L4 NI	86.T39V1.002
N/A	SCREW	SCRW M2.5*6 ~ L-CASE + U-CASE	86.00D28.330
N/A	SCREW	SCRW M2*L3	86.00D29.620
N/A	SCREW	SCRW M2.5*5 WAFER B-ZN ROHS	86.00D47.630
N/A	SCREW	SCREW M2*L3 NYLOK CR 3+	86.00E25.723
N/A	SCREW	SCREW M2*L3 NON-NYLOK CR3+	86.00E31.723
N/A	SCREW	SCREW M2.5*L6 NYLOK CR3+	86.00E33.736
N/A	SCREW	SCREW M2.5*L8 NYLOK CR3+	86.00E34.738
N/A	SCREW	SCREW M2*L8 NI NON-NYLOK	86.00E35.228
N/A	SCREW	SCREW M3x4(86.9A524.4R0)	86.9A524.4R0
N/A	SCREW	SCRW M2*4 WAFER NI	86.9A552.4R0
N/A	SCREW	SCREWNI M2*6L	86.9A552.6R0
N/A	SCREW	SCRW M2.5*L3(NON NYLOK)	86.9A523.3R0